

**Sefram**

INSTRUMENTS & SYSTEMS

# **OSCILLOSCOPE**

# **5228**

**TECHNICAL AND MAINTENANCE MANUAL**

CONTENTS

<u>PLATES</u>	
P1	Front view
P2	Top view
P3	Bottom view
P4	Right view
P5	Left view
P6	Rear view
<u>PAGE</u>	<u>1.- TECHNICAL SPECIFICATIONS</u>
1	1.1 .- General
2	1.2 .- Vertical deflection
	1.2.1 .- Operating modes
	1.2.2 .- Channels A and B
4	1.2.3 .- Channel C
	1.2.4 .- Delay line
	1.3 .- Horizontal deflection
5	1.3.1 .- Operating modes
	1.3.2 .- B1 sweep
6	1.3.3 .- B1 triggering
8	1.3.4 .- B2 sweep
	1.3.5 .- B2 triggering
9	1.3.6 .- XY mode
	1.4 .- Function controls
	1.5 .- DC voltage measurement
	1.5.1 .- Input
10	1.5.2 .- Display
	1.5.3 .- Sensitivity
	1.6 .- Time measurement ( $\Delta t$ )
	1.6.1 .- Delay assignment
11	1.6.2 .- Display
	1.6.3 .- Sensitivity
	1.7 .- Measurement of vertical offset between B1 and B2 ( $\Delta$ DIV)
12	1.8 .- CRT
	1.9 .- Miscellaneous outputs
	1.9.1 .- Probe adjustment

PAGE

13	1.9.2 .- B1 and B2 pulses
	1.9.3 .- Channel B Y signal output
	1.9.4 .- Active probe power supply
14	1.10.- Line power supply
	1.11.- Environmental conditions
	1.12.- Dimensions and weight
	1.13.- Accessories
15	1.14.- Safety rules
	<b>2.- <u>OPERATION</u></b>
17	2.1 .- Preparation for use
	2.1.1 .- Handle
	2.1.2 .- Switching on - Line voltage selector - Fuse
18	2.2 .- Controls and input/output terminals
	2.2.1 .- Switching on - Trace adjustment
19	2.2.2 .- Operating mode selection
25	2.2.3 .- Vertical deflection
27	2.2.4 .- Horizontal deflection
29	2.2.5 .- " $\Delta t - V - \Delta \text{DIV}$ " measurement - Digital display
30	2.2.6 .- Rear panel
31	2.3 .- Operating procedure
	2.3.1 .- Switching on
32	2.3.2 .- Selection of functions and trace adjustment
	2.3.3 .- Utilization of vertical channels
34	2.3.4 .- B1 sweep operation and triggering
	2.3.5 .- "XY" mode operation
35	2.3.6 .- Delayed B2 sweep operation
36	2.3.7 .- Utilization of alternated B1 and B2 sweeps, " $\Delta \text{DIV}$ " measurement
	2.3.8 .- Front panel configuration save
	2.3.9 .- Utilization of M1 and M2 function memories
37	2.3.10.- DC voltage measurement
38	2.3.11.- Differential time measurement
	<b>3.- <u>DESCRIPTION OF CIRCUITS</u></b>
40	3.1 .- General
41	3.2 .- LV Power supply
42	3.3 .- HV - Bright-up
	3.3.1 .- Converter
	3.3.2 .- Cathode voltage and regulation
	3.3.3 .- PDA voltage
	3.3.4 .- Control grid bias

<u>PAGE</u>	
43	3.3.5 .- Quadripole - Geometry - Focus
	3.3.6 .- Bright-up amplifier
44	3.4 .- Control keyboard
	3.5 .- Function selection logic
	3.5.1 .- X mode
45	3.5.2 .- x10 expansion
	3.5.3 .- 20 MHz reduced bandwidth
46	3.5.4 .- Y mode
	3.5.5 .- "ALT"/"CHOP" selection
	3.5.6 .- Power supply - Front panel selection save and memories M1 and M2
47	3.5.7 .- B1 trigger filter
	3.5.8 .- B2 "RUNS"/"TRIG"
	3.5.9 .- B1 "AUTO"/"NORM"/"SING SWP"
48	3.6 .- Triggering logic
	3.6.1 .- B1 trigger source
	3.6.2 .- B1 trigger channel switching logic
49	3.6.3 .- B2 trigger source selection and switching
	3.7 .- Keyboard function storage
50	3.8 .- Y channel switching logic
	3.8.1 .- Switching program
51	3.8.2 .- Switching modes
	3.8.3 .- PROM control functions
	3.8.4 .- Calibrator
53	3.9 .- Trigger switching
	3.9.1 .- B1 trigger
	3.9.2 .- B2 trigger
	3.9.3 .- External trigger input
	3.9.4 .- Y signal output
54	3.10.- B1 - B2 triggering
	3.10.1.- B1 trigger filters
	3.10.2.- Shaping and polarity
	3.10.3.- B1 "level" control operation in "automatic" and "triggered" modes
55	3.10.4.- "Automatic" flip-flop
	3.11.- B1 timebase
	3.11.1.- Sawtooth generator
56	3.11.2.- Sweep control
	3.11.3.- Dead time
58	3.11.4.- Single sweep
	3.11.5.- B2 delay circuit
	3.12.- B2 timebase
	3.12.1.- Sawtooth generator

PAGE

59	3.12.2.- Sweep control
	3.12.3.- B2 "runs" or "triggered" sweep
	3.12.3.- B2 initial voltage
61	3.13.- X mode switching - Bright-up control
	3.14.- Horizontal deflection amplifier
	3.15.- Voltmeter - $\Delta t$ - $\Delta$ Div functions
62	3.15.1.- Measurement principle
	3.15.2.- "Volt", " $\Delta t$ " or " $\Delta$ Div" selection
	3.15.3.- ADC
63	3.15.4.- Automatic range search
	3.15.5.- "Volt" mode input
64	3.15.6.- " $\Delta t$ " mode
65	3.15.7.- " $\Delta$ Div" mode
	3.16.- Display
	3.17.- Channel A and B inputs and preamplifiers
	3.17.1.- Inputs
66	3.17.2.- Attenuators
67	3.17.3.- Preamplifier
68	3.18.- Channel A and B Y amplifiers
	3.19.- Channel C
	3.19.1.- Input and attenuator
69	3.19.2.- Amplifiers
	3.20.- Common Y amplifier
	3.21.- Final Y amplifier
70	3.22.- Y algebraic addition - Trace separation
	3.22.1.- Operating point hold for "A + B" algebraic addition mode
	3.22.2.- Trace separation
	<b>4.- MAINTENANCE</b>
71	4.1 .- Maintenance of the front panel
	4.2 .- Access to internal elements
	4.2.1 .- Removal of covers and handles
73	4.2.2 .- Removal of Y mode sub-assembly
75	4.2.3 .- Removal of X mode sub-assembly
76	4.2.4 .- Removal of power supply sub-assembly
77	4.2.5 .- CRT disassembly
78	4.2.6 .- CRT reassembly
	4.2.7 .- Removal of PDA sub-assembly
	4.2.8 .- Removal of card Z8
	4.2.9 .- Removal of graticule illumination system
79	4.3 .- Equipment required for repair and adjustment operations
80	4.4 .- Adjustment
	4.4.1 .- Power supply

<u>PAGE</u>	
82	4.4.2 .- Vertical deflection
84	4.4.3 .- Triggering
	4.4.4 .- Horizontal amplifier
	4.4.5 .- Timebase
86	4.4.6 .- Voltage measurement
	4.4.7 .- $\Delta t$ mode
	4.4.8 .- $\Delta$ Div mode

FIG.5.- SCHEMATICS

1	Interconnection
2	Low voltage power supply
3	Bright up - EHT - P.A.
4	Memory
5	Logic (1)
6	Logic (2)
7	Triggering logic
8	Y logic
9	Trigger switching
10	Front panel keyboard
11	B1 - B2 triggering
12	B1 Time base
13	B2 Time base
14	B1 Time/div switch
15	B2 Time/div switch
16	X and bright up switching
17	Horizontal amplifier
18	Voltmeter
19	Voltmeter display
20	Channels A and B input
21	Channels A and B preamp.
22	Channels A and B amplifier
23	Channel C
24	Common Y amplifier
25	Y output amplifier
26	Y sum - Trace separation

PAGE

6.- MECHANICAL PARTS LIST

6-1	6.1 .- Rear view
6-2	6.2 .- Front view
6-4	6.3 .- Left side
6-5	6.4 .- Right side
6-6	6.5 .- Top view
6-8	6.6 .- Bottom view

7.- GENERAL PARTS LIST

## 1.- TECHNICAL SPECIFICATIONS

### 1.1.- GENERAL

The 5228 oscilloscope has a bandwidth up to 250 MHz, double timebase and three separate vertical channels.

Channels A, B and C can be used separately or simultaneously in the "sweep alternate" or "chopped" mode, and in the algebraic addition mode ( $A \pm B$ ). Channel B can be inverted.

The double timebase (B1, B2) provides a choice of the following sweep modes : B1 only, B1 + B2 delayed and extra-bright, B2 delayed only, B1 and B2 mixed, and B1 and B2 alternated.

Triggering can be controlled internally from channel A, B or C, line source, or an external signal. Triggering over 250 MHz is also possible.

Y mode, X mode and B1 and B2 trigger mode controls are incorporated in a keyboard. LEDs come on to indicate selected functions. Utilization of this keyboard is further improved by the inclusion of two preselected function memories.

The oscilloscope also has a digital display, used for measurement of DC voltages applied to a "voltmeter" input, or for display of  $\Delta$ div vertical offset between the B1 and B2 sweeps ("sweep alternate" mode), or display of the  $\Delta t$  time interval between any two points of a phenomenon observed on the screen.



**1.2.- VERTICAL DEFLECTION**

The identical A and B channels, and the simplified C channel each have a power switch with "on" lamp, input coupling selector, sensitivity selector, and shift control (dynamic range : 3 screen widths).

Shift indication is on two lamps.

Channel B also has a signal inversion key.

**Note** : A key is also provided for reducing bandwidth to 20 MHz on all 3 channels, for certain special applications.

**1.2.1.- Operating modes**

The channels in service can be alternated on each sweep, or chopped at a fixed frequency (in the "chopped mode", each channel is present for approx. 1  $\mu$ s).

**Basic modes :**

A B C	3 independent displays : channel A, channel B and channel C.
A+B C	2 displays : channel C and algebraic addition of channels A and B.
A A+B B C	4 displays : channels A, B and C, and algebraic addition of channels A and B.

**Derived modes :**

- Each channel (A, B or C) can be cut off (lamp out), and it is therefore possible to work with 1, 2, 3 or 4 traces. The trigger sources are not affected by channel deselection.

- An inverter control for channel B gives a choice of input signal addition or difference in the "A+B" mode.

**1.2.2.- Channels A and B****Input characteristics**

- **Input impedance** (no probe)

Two selectable impedance values :

**High impedance** :  $1 \text{ M}\Omega \pm 2\%$  shunted by  $20 \text{ pF} \pm 2 \text{ pF}$

**Low impedance** :  $50 \Omega \pm 2\%$

- 3 -

**- Max. admissible input voltage :**

into 1 M $\Omega$  :  $\pm$  250 V DC (including superimposed signal peaks), or  
500 V AC pp (frequency  $\leq$  1 kHz)

into 50  $\Omega$  :  $\pm$  5 V DC or 500 mW

**Input mode**

Three selectable input modes :

DC : direct signal input with DC component

0 : signal disconnected and amplifier input grounded

AC : signal DC component filtered out ( $F > 2$  Hz)

**Sensitivity**

- 11 ranges from 2 mV/div to 5 V/div, selectable on rotary switch (1 - 2 - 5 séquence).

- Progressive gain adjustment control (ratio  $\geq$  2.5), with lamp coming on to indicate "uncalibrated" state.

- Calibration accuracy ("Cal" position) :  $\pm$  3%.

**Bandwidth and rise time** (input : 50  $\Omega$  or 1 M $\Omega$ )

Sensitivity	Bandwidth at - 3 dB	Calculated rise time
5 V to 10 mV/div	250 MHz	1.4 ns
5 mV/div.	200 MHz	1.75 ns
2 mV/div.	100 MHz	3.5 ns

(Rise time from + 10% to + 90% is calculated on the basis of "0.35/bandwidth").

- Bandwidth : the reference level at 50 kHz is five divisions on the internal CRT graticule

- Pulse response : the reference level is five divisions on the internal CRT graticule.



- . ALT : "B1+B2" and "B2" modes alternated. A control is provided for separating the B2 trace with respect to B1, over a range of  $\pm 8$  divisions on the screen. Separate B1 brightness adjustment.
- . XY : vertical deflection signal selected by Y mode, and horizontal deflection signal selected by B1 trigger source.
- . x10 : horizontal deflection expanded by a factor of 10.

### 1.3.2.- B1 sweep

#### Sweep rate

- 24 calibrated ranges from 10 ns/div. to 0.5 s/div. (1 - 2 - 5 sequence). Max. sweep rate increased to 1 ns/div. in "x10" mode.
- Progressive adjustment control (ratio > 2.5) with "Uncal" lamp.
- Calibration accuracy (control in "Cal" position) :  $\pm 3\%$ .  
Add  $\pm 2\%$  in "x10" mode, excluding 0.5 div. or 15 ns at start of B1.

#### Hold off

"Hold off" control for variation of B1 sweep repetition without changing time/div. calibration.

#### Delay system

- "DELAY 1" 10-turn control for selecting B2 sweep start at 0.5 div. to 10 div. (0.5 to 10 times the B1 deflection factor).
- Jitter :  $\leq 1/20\ 000$  of total B1 sweep.

**1.3.3.- B1 triggering****Trigger source**

A : Internal signal from channel A

B : Internal signal from channel B

C : Internal signal from channel C

**ALT** : Internal signal delivered alternately by channels A, B and C when each is in service. The trigger signal is delivered by channel A for the "A+B" mode. "ALT" triggering cannot be used in the "chopped" Y mode.

**LINE** : Signal from power supply source at line frequency

**EXT** : External signal applied to "EXT TRIG" input  
 . Input impedance :  $1\text{ M}\Omega$  shunted by  $20\text{ pF} \pm 2\text{ pF}$   
 . Max. admissible voltage :  $\pm 250\text{ V}$  DC (including superimposed signal peaks), or  $500\text{ V AC pp}$  ( $F \leq 1\text{ kHz}$ )  
 . The input signal can be attenuated by a factor of 10.

**Trigger signal transmission mode**

 direct transmission of signal with DC component

 AC transmission ( $F > 10\text{ Hz}$ )

 integrated transmission, avoiding triggering on HF signals (cut-off at - 3 dB for  $F > \text{approx. } 10\text{ kHz}$ )

 differentiated transmission, avoiding triggering on LF signals (cut-off at - 3 dB for  $F < \text{approx. } 10\text{ kHz}$ ).

Sweep control modes

- AUTO** Automatic mode : sweep occurs even in the absence of a trigger signal. In the presence of input signals (sine-wave, min. amplitude > 2 div. at 1 kHz), sweep is triggered automatically irrespective of trigger level position.
- NORM** Normal triggered mode : sweep starts on a trigger signal.
- SINGL SWP** Single sweep mode : a single sweep is triggered (reset pushbutton and lamp).

Trigger level and polarity

	Normal	Automatic
1227 W	0 to > 250 MHz 10 Hz to > 250 MHz 0 to approx. 10 kHz approx. 10 kHz to > 250 MHz	25 Hz to > 250 MHz 25 Hz to > 250 MHz 25 Hz to approx. 10 kHz approx. 10 kHz to 250 MHz

Min. trigger level

	0 to 25 Hz	25 Hz to 20 MHz	20 to 100MHz	100 to 250MHz
INT NORM	0.8 div.	0.8 div	1.2 div	2 div
AUTO with level		0.8 div	1.2 div	2 div
EXT. 1	100 mV cc	100 mV cc	150 mV cc	200 mV cc

**1.3.4.- B2 sweep****Sweep rate**

- 21 calibrated ranges from 10 ns/div. to 50 ms/div. (1 - 2 - 5 sequence). Max. sweep rate increased to 1 ns/div. in "x10" mode.
- Calibration accuracy : + 3%  
Add + 2% for "x10" mode, excluding 0.5 div. or 15 ns at start of B2.  
"Mixed" mode : exclude 0.2 div. or 5 ns for B2, after start of delay system.

**1.3.5.- B2 triggering****Sweep control modes**

- RUNS : B2 sweep starts at end of selected delay.  
Jitter : 1/20,000 of total B1 sweep.
- TRIG : B2 triggered by trigger signal after selected delay.

**Trigger source**

- A : Internal signal from channel A
- B : Internal signal from channel B
- C : Internal signal from channel C
- ALT : Internal signal delivered alternately by channels A, B and C, when each is in service. The trigger signal is delivered by channel A for the "A+B" mode. "ALT" triggering cannot be used in the "chopped" Y mode.
- EXT : External signal applied to "EXT TRIG" input.  
(Input characteristics : see paragraph 1.3.3).

**Trigger signal transmission mode** : direct transmission of signal  
with DC component

### Level and polarity

Trigger level adjustable on control, with triggering on signal rise or fall edge (deviation : approx. 3 screen widths for internal triggering).

### Min. trigger level

As for B1 triggering (see paragraph 1.3.3), with max. frequency 200 MHz.

### 1.3.6.- XY mode

Vertical deflection by channels selected in Y mode : A, B or C (sensitivity 5 V to 2 mV/div).

Horizontal deflection by selected B1 trigger source.

X calibration accuracy :  $\pm 5\%$

Phase shift between channels X and Y with  $F \leq 1$  MHz :  $\leq 3^\circ$ .

The "chopped" mode can be used, giving 3 XY displays.

## 1.4.- FUNCTION CONTROLS

The Y mode, X mode and B1 and B2 trigger mode controls are incorporated in a keyboard, comprising a set of pushbuttons and corresponding lamps.

When oscilloscope power is switched off, selected functions are saved, and are automatically reselected when power is switched on again.

The "M1" and "M2" pushbuttons can each be used to store a complete selected function configuration. The "RCL" pushbutton is used for subsequent retrieval of one or other of the stored configurations.

## 1.5.- DC VOLTAGE MEASUREMENT (Voltmeter)

Measurements are made with respect to oscilloscope ground.

### 1.5.1.- Input

- Input impedance : approx. 10 M $\Omega$
- Max. admissible voltage : 1.5 kV.



### 1.5.2.- Display

- 7-segment electroluminescent display elements + decimal point, digit height 8 mm. Capacity : 3 1/2 digits (max. display value : 1999).
- Unit : volt (indicated by lamp on in "voltmeter" mode).
- Polarity : selected automatically.

### 1.5.3.- Sensitivity

- 4 ranges : switched automatically :
  - full scale : 1.999 V
  - 19.99 V
  - 199.9 V
  - 1999 V (limited to 1500 V for reasons of safety)
- Min. resolution : 10 mV
- Calibration accuracy :  $\pm$  (1% full scale + 1 digit)  
(+ 23°C with RH < 80%)

## 1.6.- TIME MEASUREMENT ( $\Delta t$ )

Measurement conditions :

- X mode : B1 + B2, B2 or ALT.
- B2 trigger : RUNS
- B1 TIME/DIV : 0,2 s à 0,1  $\mu$ s
- B1 control in "Cal" position.

The "Delay 2" control is used (identical to "Delay 1")

The value displayed is time difference  $\Delta t$  between "delay 1" and "delay 2".

### 1.6.1.- Delay assignment

- Single channel or "chopped" Y mode, each channel in service receives delays 1 and 2.
- "Sweep alternate" Y mode (A and B) : delay 1 is assigned to channel A, and delay 2 to channel B.
- "Sweep alternate" Y mode with channel C in service : delay 1 is assigned to channel C, and delay 2 to channels A and B.

1.6.2.- Display

- Unit : ms,  $\mu$ s or ns (lamp)
- Polarity : automatic selection
  - + when delay 1 precedes delay 2
  - in opposite case

1.6.3.- Sensitivity

- 19.99 ns to 1999 ms full scale
- calibration accuracy : B1 sweep rate accuracy  $\pm$  (1% full scale + 1 digit)

1.7.- MEASUREMENT OF VERTICAL AMPLITUDE BETWEEN B1 AND B2 ( $\Delta$  DIV)

Measurement is executed in the "ALT" X mode, using the "TRACE SEP" control. Vertical amplitude value is displayed automatically in "div".

Resolution : 0.01 div.

Measurement full scale :  $\pm$  8 div.

Accuracy (at + 23°C) :  $\pm$  (1% full scale + 1 digit).

**1.8.- CRT****- Screen**

- . flat base rectangular
- . blue filter
- . internal graticule graduated in 8 x 10 div. (1 div. = 1 cm) with adjustable brightness
- . phosphor : P31
- . PDA voltage : 18 kV

**- Beam modulation by external signal :**

- . rear panel BNC coaxial connector
- . spot blanking by positive voltage (approx.  $\geq 5$  V)
- . input impedance : approx. 5 k $\Omega$
- . max. admissible voltage :  $\pm 15$  V
- . bandwidth : 0 - 50 MHz

**1.9.- MISCELLANEOUS OUTPUTS****1.9.1.- Probe adjustment**

- . Front panel terminal delivering positive square wave signal.
- . Amplitude : 0.5 V  $\pm$  3%.
- . Frequency : between 500 Hz and 2 kHz.

**1.9.2.- B1 and B2 pulses**

- . Rear panel BNC coaxial connectors, delivering positive pulses with width as B1 and B2 sawtooths.
- . Amplitude (TTL) : "0" level  $\leq + 0.4$  V  
"1" level  $\geq + 2.4$  V
- . Maximum load : one TTL output.

**1.9.3.- Channel B Y signal output**

- . Rear panel BNC coaxial connector.
- . Amplitude : approx. 100 mV/div.
- . Internal impedance : 50  $\Omega$
- . Bandwidth at - 3 dB : 0 - 50 MHz.

**1.9.4.- Active probe power supply**

Two rear panel connectors delivering  $\pm 15$  V and + 5 V power supply voltages for active probes.

**1.10.- LINE POWER SUPPLY**

FREQUENCY	LINE SOURCE	REGULATION RANGE
48 to 63 Hz	110 V	99 to 121 V
	127 V	115 to 140 V
	220 V	198 to 242 V
	240 V	214 to 260 V
380 to 420 Hz	110 V	107 to 121 V
	127 V	123 to 140 V
	220 V	213 to 242 V
	240 V	230 to 260 V

Consumption : approx. 110 VA.

**1.11.- ENVIRONMENTAL CONDITIONS**

**Temperature**

Service : 0° to + 55°C  
Performance guaranteed : + 10° to + 40°C  
Storage : - 20° to + 70°C

**RH test**

93% RH at + 40°C for 6 hours

**Vibration test**

Frequency : 5 to 55 Hz  
Amplitude : 0.15 mm  
Duration : 10 minutes on each axis

**1.12.- DIMENSIONS AND WEIGHT**

Height : 177 mm  
Width : 300 mm  
Depth : 450 mm

Weight : 11 kg approx.

**1.13.- ACCESSORIES**

**- Supplied with oscilloscope**

- . Operator manual
- . 2 passive 1/10 probes
- . Protective cover ref. 53210
- . Viewing hood ref. PS 2303
- . Line power cable

**- Supplied as optional extras**

- . Maintenance manual
- . Carrying case
- . Accessories kit ref. 53203
- . Cameras
- . Rack integration adaptor ref. 53310
- . 1/10 and 1/100 active probes
- . Trolley, etc.

**1.14.- SAFETY RULES**

This oscilloscope is manufactured and tested in accordance with the requirements of Class I of French standard NF 20030 and IEC publication No. 348 : "Safety rules for electronic measuring instruments", and is supplied in good working condition.

The following warnings must be duly observed by the user, to ensure correct operation of the oscilloscope and its maintenance in good condition insofar as safety is concerned.

**Preparation for use**

- a) Check that the oscilloscope power supply voltage is the same as local supply source.
- b) Check the presence of a protective ground connection on the line distribution circuit used.

**Maintenance**

- a) Disconnect the oscilloscope from line power supply before starting any maintenance work.
- b) Capacitors can remain charged at dangerous contact voltages (> 50 V), more than 10 seconds after disconnection from line power supply.
- c) All adjustment, maintenance and repair operations on the oscilloscope, with the cover removed and power on, must only be undertaken by qualified personnel, fully familiar with the risks involved.
- d) Ensure that only appropriate fuses of the specified type are used for replacement. The use of over-rated fuses, fuses of a different type or straps is illegal.



**2.- OPERATION****2.1.- PREPARATION FOR USE****2.1.1.- Handle**

The handle can be used in three positions : carrying position, "prop" position under the oscilloscope, with the latter used in the inclined position, and on top of the instrument, disengaging the front panel when the oscilloscope is positioned horizontally.

Pull the handle out to change its position.

**2.1.2.- Switching on - Line voltage selector - Fuse**

Before switching on oscilloscope power, check that the rear panel voltage selector is set correctly for local line supply, and that the correct fuse is fitted.

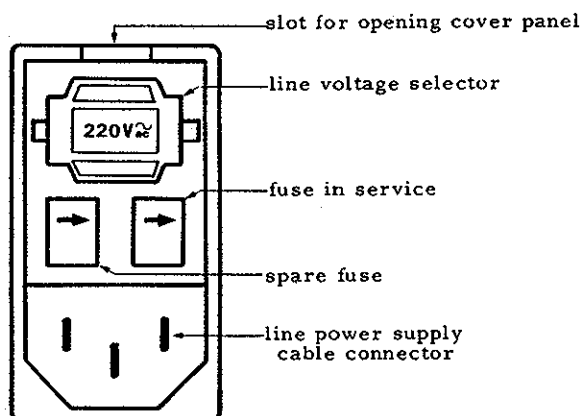
**CAUTION**

The following procedure must be followed for resetting the line voltage selector :

- . Open the cover panel by inserting a screwdriver in the upper slot.
- . Do not attempt to turn the voltage selector in its recess, at the risk of destroying the mechanism, but extract first (using tweezers if necessary).
- . After extracting the selector, set in the appropriate position, replace in its recess, and close the cover panel.



The two fuse-holders located under the voltage selector must be extracted and permutated each time line voltage is changed (110 - 127 V to 220 - 240 V or vice versa). The black fuse (0.63 A type D1TD) is for 220 V or 240 V. The white fuse (1.2 A type D8TD) is for 110 V or 127 V. The selected fuse must be in the right position, with the second fuse (not in use) on the left.

A warm-up period of about 20 minutes is required for stabilization of the circuits.

## 2.2.- CONTROLS AND INPUT/OUTPUT TERMINALS (see plate P1)

### 2.2.1.- Switching on Trace adjustment

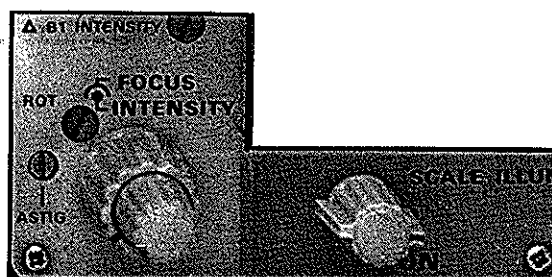

R251	SCALE ILLUM	Control for : a) Switching the oscilloscope on or off (fully anticlockwise position) b) Adjustment of graduated screen graticule brightness
R45a	INTENSITY	Trace brightness adjustment control
R45b	FOCUS	Trace focus adjustment control
R61	ASTIG	Astigmatism control, adjusted conjointly with R45b
R74	ROT	Trace rotation control for adjustment of sweep horizontality
R208	B1 INTENSITY	B1 sweep brightness control ("ALT" X mode), independently from B2 brightness

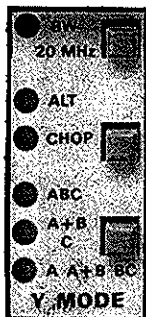
2.2.2.- Operating mode selection (keyboard)1) Y mode

S11	BW	Selection of normal bandwidth, or 20 MHz reduced bandwidth.
CR19	20 MHz	Lamp indicating 20 MHz bandwidth.
S1		Pushbutton for selection of "sweep alternate" or "chopped" mode.
CR1	ALT	Lamp indicating "sweep alternate" mode. The channels in service are alternated on each sweep.
CR2	CHOP	Lamp coming on to indicate "chopped" mode. The channels in service are switched at a fixed frequency (approx. 1 MHz).
S2		Pushbutton for selection of Y operating mode (repeated pressure). The selected mode is indicated by one of the following 3 lamps :
CR3	A B C	Inputs A, B and C, used as independent channels, are in service in turn.
CR4	A+B C	Inputs A and B constitute an algebraic addition channel, cut in alternately with channel C.
CR5	A A+B B C	Channels A, B and C, and algebraic addition channel A+B are in service in turn. <b>Note :</b> any channel (A, B or C) can be cut off, and operation is possible with 1, 2, 3 or 4 traces (derived operating modes). When no channel switch is in the "ON" position, the trace displayed on the screen is channel A.

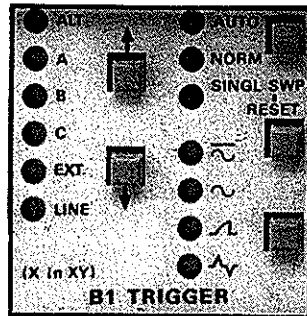
2) B1 trigger

S3	↑	Pushbuttons for selection (repeated pressure) of B1 trigger signal source, or horizontal deflection signal source (XY mode). The selected source is indicated by one of the following 6 lamps :
S4	↓	
CR6	ALT	Trigger signal delivered alternately by each channel used, when in service. For the algebraic addition mode (A+B), the trigger signal is delivered by channel A. The "ALT" trigger function cannot be used in the "chopped" Y mode.
CR7	A	Signal supplied by channel A
CR8	B	Signal supplied by channel B
CR9	C	Signal supplied by channel C
CR10	EXT	External signal applied to "EXT TRIG" input J901.
CR11	LINE	Signal from power source.
S6		Pushbutton for selection of B1 sweep control mode (repeated pressure). The selected mode is indicated by one of the following 3 lamps :
CR16	AUTO	Automatic mode : sweep occurs even in the absence of a trigger signal. If input signals are present (amplitude > 2 div.), triggering is automatic irrespective of trigger level position.

## 5228 OSCILLOSCOPE

- 21 -

CR17	NORM	Triggered mode : sweep starts when the trigger signal appears.
CR18	SINGL SWP	Single sweep mode : sweep is not repetitive, and is triggered once only. The lamp is on when this function is set, ready for triggering. The lamp flashes when a single sweep has been executed, inviting reset.
S7	RESET	Single sweep reset pushbutton.
S5		Pushbutton for selection of trigger signal transmission mode (repeated pressure). The selected mode is indicated by one of the following 4 lamps:
CR12	⎓	DC transmission
CR13	~	AC transmission ( $F \geq 10$ Hz)
CR14	~	Integrated transmission, avoiding triggering on HF signals (cut-off at approx. 10 kHz).
CR15	~	Differentiated transmission, avoiding triggering on LF signals (cut-off at approx. 10 kHz).
		<b>Note</b> : these 4 lamps are all out in the XY mode.

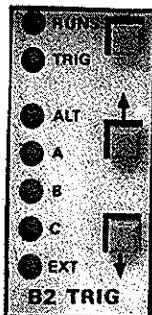
3) B2 trigger

S17		Pushbutton for selection of B2 sweep control mode.
CR32	RUNS	Lamp indicating "runs" mode, with B2 sweep starting at end of selected delay.
CR33	TRIG	Lamp indicating "triggered" mode, with B2 sweep triggered by a trigger signal after selected delay.
S15	↑	Pushbuttons for selection of B2 trigger signal source (repeated pressure). The selected source is indicated by one of the following 5 lamps :
S16	↓	
CR27	ALT	Trigger signal delivered alternately by each channel used, when in service. For the algebraic addition mode (A+B), the trigger signal is supplied by channel A. The "ALT" trigger source cannot be used in the "chopped" Y mode.
CR28	A	Signal supplied by channel A
CR29	B	Signal supplied by channel B
CR30	C	Signal supplied by channel C
CR31	EXT	Signal applied to "EXT TRIG" input. <b>Note :</b> these 5 lamps are all out for the B1, YX and B2 RUNS modes.

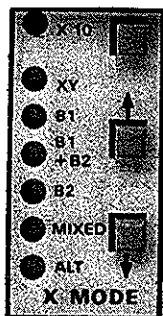
4) X mode

S12		Pushbutton for selection of normal horizontal amplitude, or horizontal amplitude expansion by a factor of 10, giving a max. sweep rate of 1 ns/div.
CR20	x 10	Lamp indicating expansion by a factor of 10.
S13		Pushbuttons for selection of horizontal mode (repeated pressure). The selected mode is indicated by one of the following 5 lamps :
S14		
CR21	XY	- XY mode : vertical deflection is provided by the signal selected for the Y mode (pushbutton S2), and horizontal deflection by the signal selected for B1 trigger (pushbuttons S3 and S4). Do not use the "ALT" or "LINE" mode for horizontal deflection. <b>Note :</b> for the XY function, only the "chopped" Y mode is in service. This gives four XY displays.
CR22	B1	- B1 sweep only.
CR23	B1 + B2	- B1 sweep appears on the screen with the part corresponding to B2 shown extra-bright, the position of the extra-bright part depending on selected delay.
CR24	B2	- B2 sweep only displayed, delayed with respect to start of B1.
CR25	MIXED	- Sweep commences at B1 sweep rate, continuing at B2 sweep rate on delayed start of B2.

CR26	ALT	<p>- The "B1 + B2" and "B2" modes, switched alternately, are visible together on the screen. The vertical offset of "B2" with respect to "B1 + B2" can be adjusted on R344 (TRACE SEP), and "B1 + B2" brightness can be adjusted to the same intensity as "B2" on R208 (B1 INTENSITY).</p>
------	-----	--

5) Memory

S8 S10	M1 - M2	<p>Pushbuttons for storage of all functions selected on the keyboard at a given moment.</p>
S9	RCL MEM.	<p>Pushbutton for instantaneous recall of one or other stored function configuration, even after the oscilloscope has been switched off for a period of time. Depress "RCL", followed by "M1" or "M2" according to the desired configuration.  <b>Note:</b> when the oscilloscope is switched off, selected front panel functions are saved, giving storage of three different configurations : front panel selections when power is switched off, M1 and M2.</p>

2.2.3.- Vertical deflection

Channels A and B

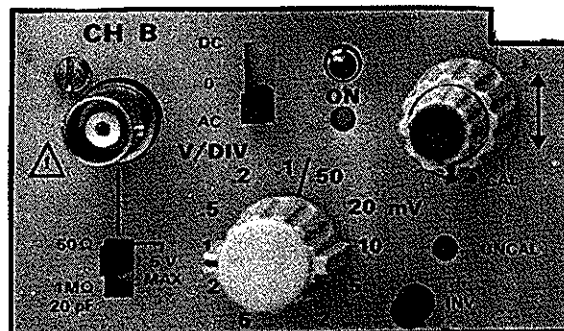
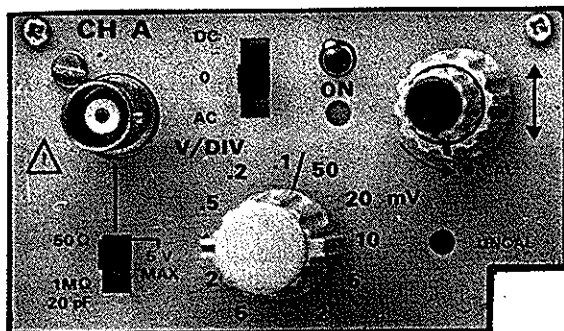



Channel A	Channel B		
S1 (Z6)	S5 (Z6)	ON	Channel power switch
CR1	CR3		Green lamp indicating that the channel is in service.
J2001	J2002		Channel input (BNC type coaxial)
S3	S7	50 Ω - 5 V max 1 MΩ - 20 pF	Input impedance selector
S2 (Z6)	S6 (Z6)		Input signal coupling mode selector :
		DC	DC coupled
		0	Signal disconnected and amplifier input grounded.
		AC	AC coupled : signal transmitted with DC component filtered out (F > 2 Hz).
S1 (Z7)	S2 (Z7)	V/DIV (2 mV to 5 V)	11-position deflection factor

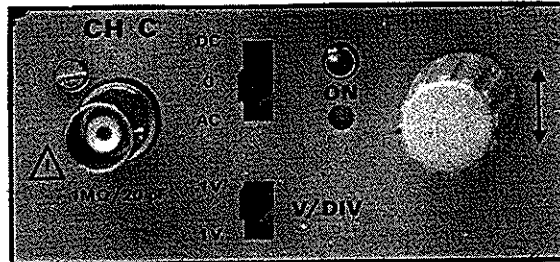

Channel A	Channel B		
R59b	R105b	CAL	Progressive deflection factor adjustment control. The "V/DIV" selector is calibrated for the extreme anti-clockwise position of this control.
CR2	CR4	UNCAL	Red lamp indicating that vertical deflection is not calibrated, with control R59b/R105b in service.
R59a	R105a	↕	Trace vertical shift control.
	S4	INV	Signal inverter pushbutton for channel B.

Channel C



S11	ON	Channel power switch
CR7		Green lamp indicating channel in service.
J2301		Channel input (BNC type coaxial).
S9	DC 0 AC	Input signal coupling mode selector (as channels A and B).
S10	V/DIV. .1 V 1 V	2-position deflection factor selector.
R226	↕	Trace vertical shift control.

Shift indicator

Calibrator

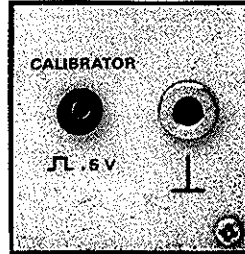

CR5 CR6		Lamps indicating vertical shift direction when the trace is off the screen.
J801	<p>CALIBRATOR</p>	Terminal delivering a positive square-wave signal for probe adjustment (amplitude 0.5 V, frequency approx. 1 kHz).
J802		Ground terminal

2.2.4.- Horizontal deflection

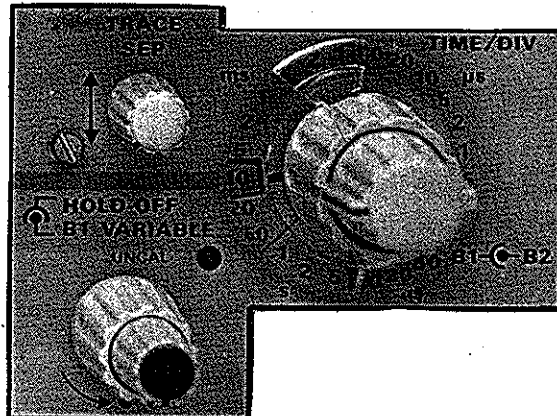
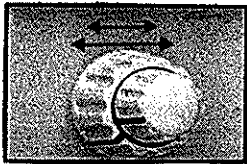

B1	B2		
S1a (Z2)	S1b (Z2)	TIME/DIV. B1 - B2	Double switch for selection of sweep rates for B1 and B2 time bases, expressed in seconds (s), milliseconds (ms), microseconds ( $\mu$ s) or nanoseconds (ns).
R122a		B1 VARIABLE 	Progressive sweep rate adjustment control, giving range overlap. This control is inoperative in the fully anticlockwise position, and the "TIME/DIV" selector is calibrated.

CR23		UNCAL	Lamp indicating that the "B1 VARIABLE" control is in service, and the "TIME/DIV" selector is not calibrated.
R122b		HOLD OFF	B1 hold-off time adjustment control. Adjusting the frequency of the sweep to that of the signal observed (without altering sweep rate), this allows synchronization on complex phenomena and DP words.
	R344	TRACE SEP	Control for adjustment of B2 vertical trace shift with respect to B1 trace (X mode : "ALT").
R240 a and b			Double horizontal trace shift control (coarse and fine).

Synchronization

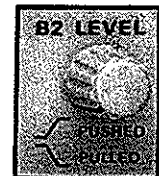
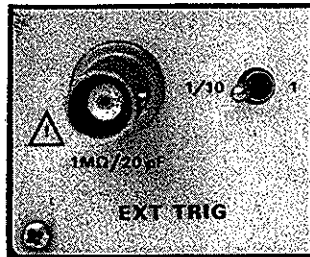

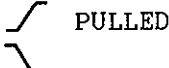
R57 R66	B1 LEVEL B2 LEVEL PUSHED	Trigger signal sweep trigger level adjustment control, with triggering on rise edge (pushed) or fall edge (pulled).
		Deviation : approx. 3 screen widths
CR9	TRIG	Lamp indicating that B1 sweep is triggered.
J901	EXT TRIG 1 MΩ/20 pF	External trigger signal input BNC coaxial connector.
S4 (Z1)	1/10 - 1	External trigger signal attenuation factor selector.

- 29 -

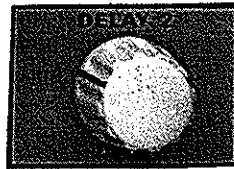
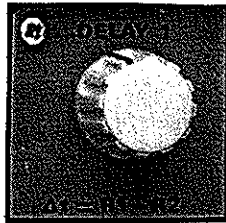
Delay system

R10 (Z3)	DELAY 1	10-turn potentiometer for selection of B2 sweep delay with respect to start of B1.
R11 (Z3)	DELAY 2	10-turn potentiometer controlling second B2 delay with respect to B1 for " $\Delta t$ " measurement. The measured difference between the two delays appears directly on the digital display. It is thus possible to identify any two points on the B1 path, and obtain an immediate reading of the time interval separating the two points, in the "B1 + B2" mode.

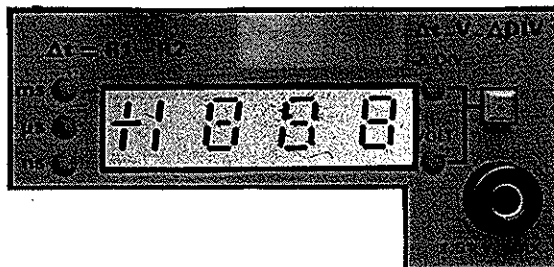
2.2.5.- " $\Delta t - V - \Delta DIV$ " measurement - Digital display

<b>Circuit</b>		
U1 to U4		7-segment, 4-digit display, with automatic decimal point and polarity sign selection
S1	$\Delta t - V - \Delta DIV$	Pushbutton for selection of one of the 3 measurement modes using the display :
CR4	VOLT	- display of DC input voltage (expressed in volts).

J1901 J1902	1.5 kV max	Measurement voltage input connector Reference ground connector for voltage measurement.
CR5	$\Delta$ DIV	- Display of vertical offset between "B2" trace and "B1 + B2" trace ("ALT" mode). This offset, expressed in graticule divisions, is selected on the "TRACE SEP" control.
	$\Delta t=R1=R2$	- Display of time interval between delay 1 and delay 2.
CR3 CR1 CR2	ms $\mu$ s ns	Lamps indicating display unit (millisecond, microsecond or nanosecond). Note : the " $\Delta t$ " function can only be selected with the "B1 + B2", "B2" or "ALT" mode, with B2 sweep at "RUNS", and the B1 control in the "CAL" position.

### 2.2.6.- Rear panel

FL201	48 - 420 Hz 110 VA 220/240 V  110/127 V	Subassembly comprising :  - Power supply cable connector. - Line voltage selector : 110 V - 127 V - 220 V - 240 V. - Two fuses : . 0.63 A type D1TD in black fuse-holder for 220 V or 240 V. . 1.2 A type D8TD in white fuse-holder for 110 V or 127 V. The fuse in service is on the right, with the other fuse on the left.  <b>CAUTION</b> : To change the position of the voltage selector, the procedure indicated on page 17 must be followed.
-------	---	---

J1201	OUTPUT	BNC coaxial connectors delivering TTL amplitude positive pulses, with pulse width equal to B1 and B2 sweep.
J1301	B1 B2	
J19	EXT MODUL.	BNC coaxial input connector for modulation of beam intensity by an external signal (max. voltage $\pm 15$ V).
J902	Y SIGNAL OUTPUT	BNC coaxial connector delivering the Y signal picked off channel B (100 mV/div., Z = 50 $\Omega$ )
J201 J202	PROBE POWER	Power supply connectors for active probes

### 2.3.- OPERATING PROCEDURE

The operations described below, together with a certain number of practical recommendations, will enable the user to familiarize himself with the oscilloscope.

#### 2.3.1.- Switching on

- . Before switching on, move all vertical shift (3 channels) and horizontal shift controls to their central positions. Set the channel A and channel B controls, and the B1 sweep control, in the fully anti-clockwise position ("CAL"). Set the power "ON" switches for channels A, B and C in the "UP" position (theoretically no channel is in service, but channel A is connected automatically in this configuration).
- . Channel A and B input selector at "0"  
B1 TIME/DIV. : 0.5 ms  
B2 TIME/DIV. : 2  $\mu$ s
- . "FOCUS" control centred, "INTENSITY" control at zero.
- . Release "ON" control R251 (turn in direction of arrow). The lamps and display come on.  
The oscilloscope is now powered. Check that graticule brightness can be adjusted by turning this control after release.

### 2.3.2.- Selection of functions and trace adjustment

- . Select B1 sweep, depressing keyboard pushbutton S13 or S14 ("X MODE" compartment) a number of times until the "B1" lamp comes on. Select "AUTO" sweep mode on pushbutton S6 ("B1 TRIGGER" compartment).
- . Then turn the "INTENSITY" control slowly clockwise, until a trace with medium brightness is obtained on the screen. Adjust trace thickness on the "FOCUS" control, readjusting the "ASTIG." preset control if necessary. Adjust sweep horizontality on the "ROT." preset control, as required.

### 2.3.3.- Utilization of vertical channels

- . Channels A, B and C : DC coupled input, "ON" switches in "down" position (green lamps on).
- . Select "A B C" mode on pushbutton S2 ("Y MODE" compartment). Three horizontal traces appear on the screen, corresponding to channels A, B and C. Position the traces on the screen, using the vertical shift controls.

#### - Utilization of a single channel

- . Connect a signal generator (oscilloscope ".5 V" output terminal J801 for example) to one input (CHANNEL A input, sensitivity 0.2 V/div., input impedance 1 M $\Omega$ , for example). The signal appears on the sweep corresponding to channel A, with an amplitude of 2.5 div. Select channel A as the trigger source (pushbuttons S3 and S4 in "B1 TRIGGER" compartment). Observe the effect of the channel A progressive sensitivity control (R59b), turning this control clockwise, away from its "CAL" position. Amplitude of the signal displayed on the screen decreases.

The above procedure for channel A is also valid for channel B.

**- Simultaneous utilization of more than one independent channel**

Apply two separate signals from two generators to channel A and channel B, selecting sensitivity for each channel, and B1 sweep TIME/DIV. value as appropriate. Observe that if the "B1 TRIGGER" source is "A", only channel A is triggered, and if the "B1 TRIGGER" source is "B", only channel B is triggered. Use the "ALT" Y mode, and select "B1 TRIGGER" at "ALT" (alternated source) to trigger both channels simultaneously.

When a channel is not used (channel C for example), it is advisable to switch the unused channel off setting the corresponding "ON" switch in the "up" position, to avoid jitter resulting from the automatic sweep time constant.

**- Utilization of inputs A and B in the algebraic addition mode (A+B)**

Y MODE : "A B C", "ALT".

B1 TRIGGER : "AUTO", "ALT".

Channels A and B : sensitivity 0.5 V/div., input impedance : 1 M $\Omega$ .

Channel C : off

Apply the signal from the ".5 V" output terminal to inputs A and B in parallel, and observe a pulse with an amplitude of 1 div. on each channel.

Select Y mode "A + B, C". The signal displayed represents the sum of signals A + B, and pulse amplitude is consequently 2 div.

Depress the "INV" inverter pushbutton for channel B. Inputs A and B are used in the differential channel mode. The signal displayed represents the difference A - B, and pulse amplitude is zero.

**- Derived Y modes**

A number of derived modes can be obtained from the three basic Y modes (selected on pushbutton S2), by eliminating one or more channels (channel "ON" switches), and by using the channel B inverter pushbutton.



#### 2.3.4.- B1 sweep operation and triggering

##### **Level and polarity**

X mode : "B1" - B1 TIME/DIV. : 0.2 ms.

Apply a sine-wave signal (frequency 1 kHz, amplitude 2 to 5 div.) to channel A, used in the single channel mode.

B1 TRIGGER : "AUTO" and "A".

Adjust the "B1 LEVEL" control, and check that the sweep start point is displaced on the sine-wave. Pull or push this control to check that sweep start occurs on the rise or fall part of the signal. The signal is always triggered, irrespective of the position of this control.

##### **Normal mode**

- Select "NORM" (pushbutton S6). The action of the level control is then more rapid, and the sweep disappears as soon as the sweep start point reaches the upper or lower peak of the signal.

##### **- Single sweep mode**

In the "NORM" mode, centre the trigger level on the signal observed, and then cancel the input signal. The sweep disappears.

Select "SINGL SWP" mode on pushbutton S6. The red lamp flashes, indicating that the single sweep function must be reset. Press the "RESET" pushbutton. The red lamp stays on (not flashing), indicating that the single sweep function is reset, and ready to operate.

Reapply the input signal. The sweep is triggered, but only one sweep is executed and the red lamp flashes. Check that a single sweep is executed each time the "RESET" pushbutton is depressed.

#### 2.3.5.- "XY" mode operation

Select the "XY" mode on the X mode keyboard.

Readjust the "INTENSITY" control if necessary.

- 35 -

Select the vertical deflection channel or channels on Y mode pushbutton S2, and the horizontal deflection channel on the "B1 TRIGGER" keyboard (use only "ALT" or "LINE" mode for horizontal deflection).

Vertical shift is obtained on the control for the selected Y channel, and horizontal shift on double control R240a and R240b. Note also that "ALT" selection is impossible in the "XY" mode, for obvious reasons.

### 2.3.6.- Delayed B2 sweep operation

#### - B2 runs

X MODE : "B1 + B2"  
B1 TIME/DIV. : 0.5 ms  
B2 TIME/DIV. : 10  $\mu$ s  
B2 TRIGGER : "RUNS"

Apply and trigger the pulse from ".5 V" output terminal J801 on channel A, used alone (0.2 V/div.).

Adjust the "INTENSITY" control, so that the extra-bright part corresponding to the delayed B2 sweep is clearly discernible on the B1 sweep. Check that the "DELAY 1" control can be adjusted to start B2 sweep at any selected point on the B1 sweep path. It is thus possible to use the B2 sweep to demarcate a detail of the B1 sweep, for example a rise edge of the pulse observed.

Then select X mode "B2". The spot crosses the screen at B2 sweep rate (10  $\mu$ s/div.), and the B1 detail previously demarcated by the extra-bright part now extends over full screen width.

#### - B2 triggered

Select X mode "B1 + B2".

B2 TRIGGER : "TRIG" (S17). The trigger source lamps come on. Select source "A". If B2 extra-bright display does not appear on the trace, adjust the "B2 LEVEL" control.

Turn the "DELAY 1" control, and check that the extra-bright part is displaced in steps, and not continuously, from one edge of the pulse examined to the other (rise or fall edges, depending on whether the "B2 LEVEL" control is pushed or pulled).

In the "TRIG" mode, the B2 sweep does not start at the selected delay part on the B1 path (as in the "RUNS" mode), but is simply set. B2 sweep only starts when the next trigger edge appears from the selected B2 trigger source.

### 2.3.7.- Utilization of alternated B1 and B2 sweeps - $\Delta$ DIV measurement

X mode : "ALT".

The "B1 + B2" and "B2" traces are visible together on the screen. As before, this mode can be used to find a detail on the B1 sweep, displacing the extrabright part by turning the "DELAY 1" control, simultaneously observing the same detail over full screen width, using the B2 sweep.

Turn the "B1 INTENSITY" preset control, to adjust the brightness of the "B1 + B2" trace to that of the "B2" trace.

- The sweep alternate mode can also be used for vertical amplitude measurement, with read-out on the digital display, using the trace offset function. Select the " $\Delta$  DIV" display function (" $\Delta$  DIV" lamp on) on the " $\Delta t - V - \Delta$  DIV" pushbutton.

Check that the display indicates "0.00" if the B2 trace is superimposed on the B1 trace.

To measure the amplitude of the pulse for example, bring the B2 trace to a vertical position over the pulse peak, turning the "TRACE SEP" control. The display automatically indicates the offset value (expressed in div.) between B1 and B2, corresponding to the amplitude of the pulse.

- If the X mode is not "ALT" with the " $\Delta$  DIV" display function selected, the display indicates the offset value between B1 and B2, although this reading does not correspond to anything visible on the screen.

### 2.3.8.- Front panel configuration save

Switch off line power supply "ON" control R251 for a few moments, then switch power on again. Check that the functions selected before power supply interruption are automatically reselected when line power returns.

### 2.3.9.- Utilization of M1 and M2 function memories

Select a set of functions on the keyboard, corresponding to a given operation, such as :

X MODE : "B1" .

B1 TRIGGER : "AUTO", "DC", trigger source "A".

Y MODE : "ALT", "A B C".

This configuration can be stored, and subsequently retrieved from memory. Depress the "M1" memory pushbutton to store.

Then change the front panel configuration, selecting the following functions for example :

X MODE : "B1 + B2", "x10".

B2 TRIGGER : "RUNS", "EXT".

B1 TRIGGER : "ALT", "TRIG", "AC".

Y MODE : "BW 20 MHz", "CHOP", "A+B C".

Now depress the "RCL" pushbutton, followed by "M1". All functions previously selected and stored are reselected automatically on the front panel, the corresponding keyboard lamps coming on to indicate this configuration.

Two separate configurations can be stored in memories M1 and M2. To retrieve either configuration, depress the "RCL" pushbutton, followed by "M1" or "M2" as appropriate.

**Note :** All functions corresponding to the keyboard controls located below the screen (but only these functions) can be stored in this way.

### 2.3.10.- DC voltage measurement

Select the "V" (voltmeter) display function ("VOLT" lamp on) on the ( $\Delta t - V - \Delta \text{DIV}$ ) pushbutton.

Apply the voltage to be measured to "1.5 kV max." input connector J1901, and ground connector J1902. Measurement is automatic. Vary the voltage value, and check that the decimal point of the value displayed is shifted automatically, with the display unit still the volt. The + or - sign preceding the display value is also switched automatically.

**2.3.11.- Differential time measurement**

Select the " $\Delta t$ " display function on the " $\Delta t - V - \Delta \text{DIV}$ " pushbutton. If this selection is impossible, namely if the " $\Delta \text{DIV}$ " or "VOLT" lamp stays on, this means that the conditions required for " $\Delta t$ " mode operation are not met. These conditions are as follows :

- 1) X MODE : "B1 + B2", "B2" or "ALT".
- 2) B2 TRIGGER : "RUNS".
- 3) B1 VARIABLE : "CAL".

When these three conditions are met, the " $\Delta t$ " function can be selected. The "ms", " $\mu\text{s}$ " or "ns" lamp comes on, indicating the display unit. Before making the measurement, check that automatic selection of the "ms", " $\mu\text{s}$ " or "ns" lamp corresponds to the position of the B1 "TIME/DIV." selector.

**- Measurement principle**

B2 sweep delay with respect to start of B1 sweep is regulated alternately by the "DELAY 1" and "DELAY 2" controls, giving two extra-bright parts, which the user can set at any two points of the sweep, in the "B1+B2" mode.

The display indicates time interval " $\Delta t$ " between the two extra-bright parts. Polarity display is "+" if extra-bright part 1 is ahead of extra-bright part 2 on the sweep, or "-" in the reverse case.

**- Phenomenon time measurement**

X MODE : "B1+B2" (B2 "RUNS").  
 B1 TIME/DIV. : 0.2 ms  
 B2 TIME/DIV. : 2  $\mu\text{s}$

Apply and trigger the pulse from ".5 V" output terminal J801 on channel A, used alone (0.2 V/div.).

Position extra-bright part 1 on a rise edge of the pulse observed, and extra-bright part 2 on the fall edge of this pulse. Read measured pulse width on the display (approx. + 500  $\mu\text{s}$  in this case).

To improve measurement accuracy, and after positioning the two extra-bright parts in the "B1+B2" mode, it is advisable to carry out fine positioning adjustment in the "B2" mode. Two B2 sweeps ("sweep alternate" mode) then occupy the screen. Adjust one or other delay slightly, to bring the point of intersection of the two edges to the exact level required (if the two edges are of opposite direction, as in the example below), or to make the two edges coincide (if both have the same direction, as for measurement of the interval between two pulses).

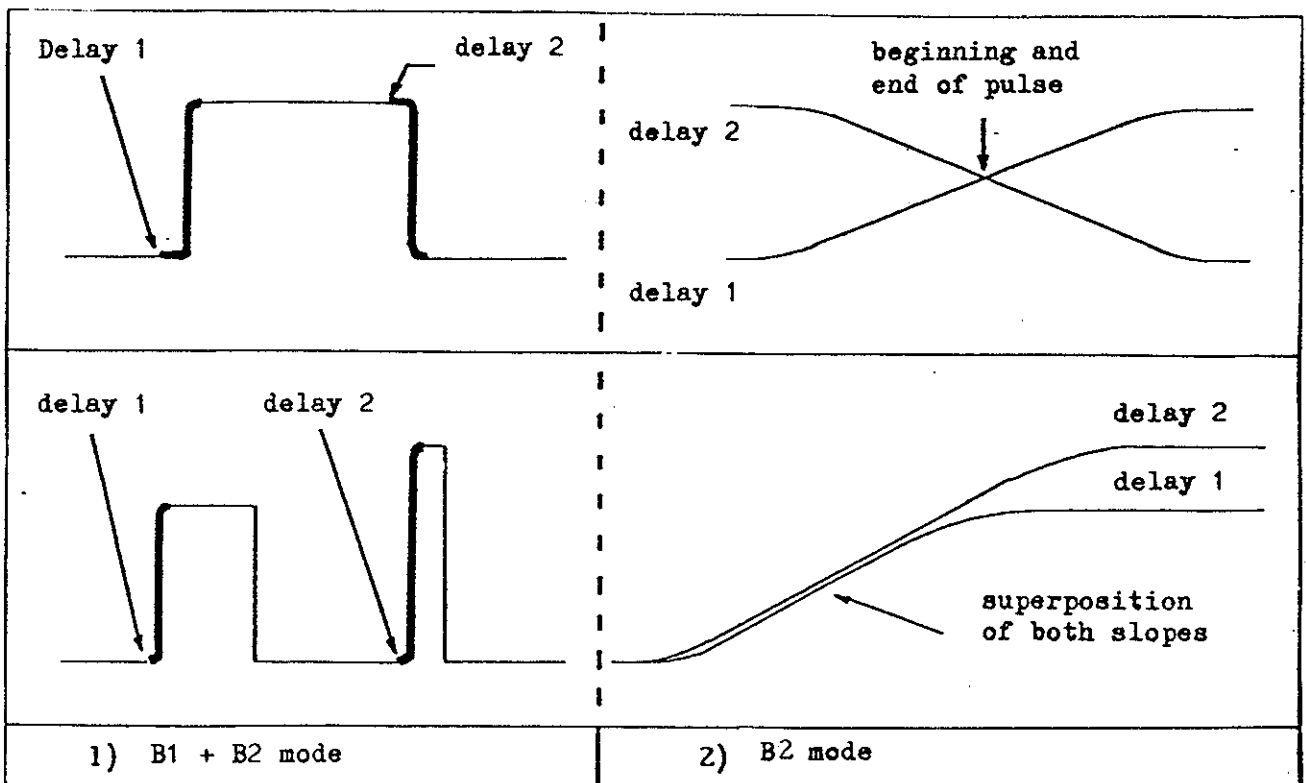

- Utilization of "Δt" function with more than one vertical channel :

X MODE : "B1 + B2" (B2 : "RUNS")  
 Y MODE : "ALT", "ABC".

If channels A and B are used alone, observe the two extra-bright parts turning the two delay controls, and check that "DELAY 1" operates on channel A, and "DELAY 2" on channel B.

Switch on channel C. Now check that "DELAY 1" operates on channel C, and "DELAY 2" on channels A and B.



### 3.- DESCRIPTION OF CIRCUITS

#### 3.1.- GENERAL

The majority of the oscilloscope circuits are grouped on three large cards :

- **backplane card Z1 :**

- . LV power supply,
- . HV power supply and bright-up amplifier (connection to the CRT via a flexible circuit),
- . function selection, channel switching, trigger channel switching and function storage logic,
- . external trigger channel.

- **right lateral card Z2 :**

- . trigger amplifiers,
- . main timebase B1,
- . delayed timebase B2,
- . horizontal switching circuits,
- . X output amplifier,
- . voltmeter and  $\Delta t$  measurement circuit.

- **left lateral circuit Z7 :**

- . vertical deflection channels A, B and C.

Other cards located behind the front panel incorporate :

- channel A, B and C inputs (Z6)
- control keyboard (Z4),
- voltmeter and  $\Delta t$  measurement circuit controls (Z3).

The Y output amplifier is mounted on a small circuit (Z8), located close to the CRT.

Details of interconnection between the different cards are given in Fig.1.



### 3.2.- LV POWER SUPPLY (Z1 - fig. 2)

The LV power supply voltages are delivered by transformer T201 from a line source. A selector on power supply module FL201 is used to match the oscilloscope to local line voltage : 110 V, 127 V, 220 V or 240 V. The oscilloscope is protected by fuse F201 (0.63 A for 220 V or 240 V ; 1.2 A for 110 V or 127 V).

The transformer has 4 secondary windings, delivering regulated or unregulated voltages, and a high isolation winding for CRT heating.

. + 15 V : this voltage is rectified by diodes CR9 and CR10, and regulated by circuit U3, driving ballast Q2 via follower 1. U3 has its own voltage reference, and a current limiter device using resistor R16. The + 15 V is adjusted on control R12. The unregulated + 20 V, picked off ahead of the + 15 V regulator stage, is protected by fuse F1. The + 15 V is used for HV power supply (fig. 3), and graticule lighting (driven by Q7).

. - 15 V : this voltage is obtained from the same winding as the + 15 V, and is rectified by diodes CR11 and CR12, and regulated by comparator U4, driving ballast Q5 via follower Q4. Current limitation is by resistor R25 and transistor Q3.

. + 5 V : this voltage is rectified by bridge CR13 to CR16, and regulated by U5 which drives ballast Q6. This voltage is used to power ECL circuits, and is adjusted by R13 to a value which must not be less than the + 5 V under any circumstances.

The transformer winding is protected by fused resistors R26 and R27.

. + 40 V : this voltage is rectified by bridge CR5 to CR8, and regulated by U2. Adjustment is on R7.

. + 120 V : this voltage is rectified by diode bridge CR1 to CR4 which are referenced to the + 40 V, and is regulated by U1 with adjustment on R3. The transformer winding is protected by R1.

### 3.3.- HV - BRIGHT-UP (Z1 - fig. 3)

#### 3.3.1.- Converter

HV power supply voltages for the CRT are generated by an oscillator operating at a frequency of approx. 25 kHz. The oscillator comprises transistor Q8, associated with transformer T1, the two primary windings of which are located in the collector circuit and base circuit respectively.

#### 3.3.2.- Cathode voltage and regulation

The cathode voltage (- 1750 V) is obtained from output 7 of the secondary of T1, by means of voltage doubler C23 - CR25 - CR24 - C24. Regulating amplifier U6 is used to compare a fraction of this voltage (adjustable on R44) with a reference voltage applied to input, thus slaving the HV by controlling the base current of Q8 via R39. The reference source is delivered by U6 (output 6), and the EHV is independent the other power supplies. Oscillation current is limited by sampling a voltage proportional to the oscillator current on the terminals of R42. This voltage is filtered (R40 - C19), and applied to the limiter input of U6.

#### 3.3.3.- PDA voltage

The PDA voltage (approx. + 17 kV) is generated by voltage multiplier cells C1 - CR1 to C20 - CR20 (moulded PDA module).

#### 3.3.4.- Control grid bias

##### Principle

The process used to apply the bright-up pulse (generated and held at a level close to 0 V) to the control grid (the voltage of which is close to that of the cathode : - 1750 V) involves the use of a carrier signal delivered by the converter. This carrier is first amplitude modulated by the signal to be transmitted, and is then offset to the HV level by capacitive transmission. The pulse is detected at this level for control grid bias.

##### Execution

The converter 25 kHz is picked off the secondary of transformer T1 (output 6), and is applied via C22 - R52, to limiter diodes CR23 - CR34, which align the high peaks of the signal (CR23) on a threshold adjusted by R81 via Q9, and the low peaks (CR34) on the bright-up pulse delivered by Q17 - Q18.

- 43 -

A modulated signal with the following form is thus obtained on the common point of CR23 - CR34 :

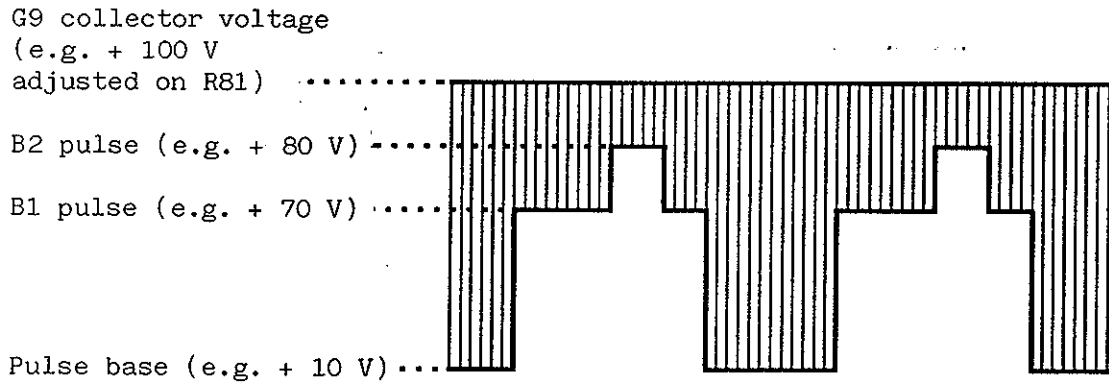

This signal is sent by C27, referenced to the cathode voltage via CR32, and detected by CR33 - C30 - R56. Detector capacitor C30 is connected to the bright-up pulse, to obtain optimum transmission of the bright-up edges to the control grid. Control R81 is used to adjust blanking according to the CRT cut-off voltage.

### 3.3.5.- Geometry - Focus

Positive half-wave rectifier stage CR26 drives zener chain CR27 to CR31. The astigmatism voltage for G4 (adjustable on front panel control R61), are picked off this stage.

Negative half-wave rectifier stage CR37 delivers the geometry voltage for G5 (adjustable on R72) and the screen voltage (adjustable on R71).

The focus voltage for G3 is obtained from doubler C28 - CR36 - CR35 - C29. The doubler reference voltage is adjusted on "focus" control R45b. Focus is also corrected according to brightness by transistors Q10 and Q11, which react to G2 current variations across R69.

### 3.3.6.- Bright-up amplifier

The bright-up pulse from the timebase, trace blanking signals from the Y logic circuits, and any signals applied to "external modulation" input J19, are applied to transistor Q12, used in the common base mode, and modulate the Q12 current.

"Intensity" control R45a is used to pick off a variable fraction of the signal delivered by Q12. This signal is sent to amplifier Q15 - Q16 - Q17 - Q18, via follower Q14. This amplifier is associated with negative feedback loop R105 - R104 - R88. The amplifier delivers bright-up pulses with an amplitude between 50 V and 100 V. Bright-up pulse high is adjusted on control R79, with low adjustment on R95.

### 3.4.- CONTROL KEYBOARD (Z4 - fig. 10)

The diagram shows the various function selector pushbuttons incorporated in the front panel keyboard (circuit Z4), and the corresponding indicator lamps.

Z4 is connected to circuit Z1 via a flexible circuit (connector J5).

### 3.5.- FUNCTION SELECTION LOGIC (Z1 - fig. 5 and 6)

TTL level : "1" : + 5 V	ECL levels : "1" : + 4.2 V
"0" : 0 V	"0" : - 3.2 V

#### 3.5.1.- X mode (fig. 5)

When pushbutton S14 is pressed ("0" on pin 42 of J5), a "1" is sent to input 10 of circuit U19 via flip-flop U18/4 - U18/3. U19 then functions in the incremental counter mode. When pushbutton S13 is pressed, U19 functions in the decremental counter mode.

Each time S13 or S14 is pressed, a pulse, inverted by U18/10 and delayed by R126 - C59, is applied to the clock input (15) of counter U19, binary input 6, 11 and 14 of which increment in one direction or the other. These outputs are connected to demultiplexer U20, which switches voltage V2 (approx. + 15 V) to one of its 6 outputs (13, 14, 15, 12, 1 or 5) according to binary input code. When an output is enabled in this way, it cuts in the selected mode (XY, B1, B1+B2, B2, Mixed or Alt), and drives the corresponding lamp (Z4 - fig. 10).

Diode CR55 is used as a limit switch in the "incremental" position (S14). When the "Alt" mode is reached, a "1" state is forced on input 8 of U18, stopping the incremental sequence. Likewise in the "decremental" position, diode CR54 functions as a limit switch when the XY mode is reached.

### Selection data storage

At any time, the selected mode, available in binary code on the outputs of U19, can be sent for storage in the memory circuits (fig. 4) via lines M16, M17 and M18, by pressing pushbutton M1 or M2 on the keyboard.

Conversely, the stored data can be retrieved via lines R16, R17 and R18, connected to the "precount" inputs of U19. When a "memory retrieval" command (line R20 at "1") appears on pin 1 of U19, the counter outputs are loaded at the precount value, thus selecting the stored mode.

### 3.5.2.- x10 expansion (fig. 5)

The pulses from pushbutton S12 are inverted by U22/4, and applied to the clock input of flip-flop U21a (D type). These pulses are used to obtain alternate "1" and "0" levels on output (1), driving relay K1 on Z2 (fig. 17), and the "x10" lamp (Z4 - fig. 10), via inverting amplifier U24/15.

The data available on output of U21, sent on line M9, can be stored at any time. The stored data is retrieved when a "memory retrieval" command ("0" level) appears on line R20. The flip-flop is then driven on its R input (4), and delivers the data received on line R9 on its output.

### 3.5.3.- 20 MHz reduced bandwidth (fig. 5)

The device used is practically identical to that for x10 expansion. It comprises "BW" pushbutton S11 and flip-flop U26, which drives an analog switch incorporated in U27. This switch directs (or not) voltage V2 to relay K1 (Z7 - fig. 24) controlling bandwidth reduction to 20 MHz, and the corresponding front panel lamp (Z4 - fig. 10).

Storage is via line M19, and retrieval (R20 at "0") via line R19.

**3.5.4.- Y mode (fig. 5)**

Flip-flops U31a and U31b are associated with gate U32/11, and receive the clock pulses from pushbutton S2 via U22/8. A "1" state is delivered in turn on output 1 of U31a, output 13 of U31b, and output 11 of U32. The following Y modes are selected by the levels delivered on lines M2 and M3 (see fig. 8) :

M2	M3	
1	0	mode A, B, C
0	1	mode A+B, C
0	0	mode A, A+B, B, C

The lamp corresponding to the selected Y mode (Z4 - fig. 10) is driven via amplifiers U33. Storage is via lines M2 and M3, and memory retrieval (line R20 at "0") via lines R2 and R3.

**3.5.5.- "ALT"/"CHOP" selection (fig. 5)**

Each pulse from pushbutton S1, sent via U28/10 and U25/10, changes the state of flip-flop U21b. Outputs 12 and 13 of U21b drive two analog switches incorporated in U29, sending voltage V2 to output 8 or output 11. These outputs are looped to input gate U28/10.

The "ALT" ("Sweep Alternate") mode is selected when output 8 is high, and the "CHOP" ("Chopped") mode when output 8 is low.

In the XY mode, flip-flop U21b is locked in the "CHOP" position. Storage is via line 1, and memory retrieval (line R20 at "0") is via line R1, with the flip-flop driven on its S and R inputs.

**3.5.6.- Power supply - Front panel selection save and memories M1 and M2 (fig. 5)**

Voltages V1 and V2 powering the logic circuits, are delivered by the + 15 V via diodes CR61 and CR60. A device principally comprising a 9 V alkaline battery and transistor Q19, is used to save front panel selections when the oscilloscope is switched off, by maintaining voltage V1 at a sufficient value (approx. 2.2 V) to protect the stored data and maintain unchanged flip-flop states.

**3.5.7.- B1 trigger filter** (fig. 6)

Flip-flops U34 are associated in such a way that they deliver binary data in sequences of 4, on outputs 1 and 13, when clock pulses are received, via U25/4, from pushbutton S5 (Z4 - fig. 10) :

	Pin 1 of U34	Pin 13 of U34
pulse n	1	1
pulse n + 1	0	1
pulse n + 2	0	0
pulse n + 3	1	0
pulse n + 4	1	1
etc.		

These data are applied to demultiplexer U35, which switches voltage V2 (sent via U33/10) to one of the four outputs (12, 13, 14 or 15), according to binary input code. These outputs control selection (Z2 - fig. 11) of the B1 trigger filter ( $\bar{\Lambda}$ ,  $\sim$ ,  $\wedge$  or  $\Lambda_V$ ), and illumination of the corresponding lamp (Z4 - fig. 10).

In the XY mode, the voltage from U33/10 is 0 V, and in this case no output is enabled, and all lamps are out.

Storage is via lines M6 and M7, and memory retrieval (R20 at "0") is via lines R6 and R7, with the flip-flops driven on their S and R inputs (via U23/4 and U23/10).

**3.5.8.- B2 "RUNS"/"TRIG"** (fig. 6)

The device is practically identical to that used for "ALT"/"CHOP" selection (see paragraph 3.5.5). It comprises flip-flop U36 and switches U29/2 and U29/3, the outputs of which (looped to input gate U28/11) control B2 "RUNS" or "TRIG" mode selection (Z2 - fig. 13).

Storage is via line M8, and memory retrieval via lines R8.

**3.5.9.- B1 "AUTO"/"NORM"/"SING SWP"** (fig. 6)

The device is similar to that used for Y mode selection (paragraph 3.5.4). It comprises two flip-flops U37 and gate U30/3, delivering a "1" state alternately on each output, and analog switches U27, which switch the voltage from U24/2 to the lamp corresponding to the selected mode.

- 48 -

U37/1 (line M4)	U37/13 (line M5)	U30/3
0	0	1
1	0	0
0	1	0

"AUTO" mode (2 of J6 at "1")  
 "TRIG" mode (2 of J6 at "0")  
 "SINGL SWP" mode (line M5 at  
 "1", "1" of J2 at "0")

In the "SINGL SWP" mode, when the "RESET" pushbutton is pressed, a short positive pulse is sent to pin 1 of J2, via pin 25 of J5 and C71, resetting the Single Sweep function. Until the "RESET" pushbutton is pressed, a positive voltage is applied to pin 2 of J2, releasing oscillator U25/12 - R156 - C73. The oscillator generates LF interruptions of power supply to the lamp, via Q20, and the lamp flashes.

Storage is via lines M4 and M5, and memory retrieval (line R20 at "0") via lines R4 and R5, with flip-flops U37 driven on their R and S inputs.

### 3.6.- TRIGGERING LOGIC (Z1 - fig. 7)

#### 3.6.1.- B1 trigger source

The device is similar to that used for X mode selection (see paragraph 3.5.1), and is driven by pulses from keyboard pushbuttons S3 and S4, on pins 15 and 16 of J5. The device comprises incremental/decremental counter U45 and demultiplexer U46, which switches voltage V2 to one of its 6 outputs, according to selected trigger source (ALT, A, B, C, EXT or LINE). The limiter diodes are CR75 (incremental) and CR74 (decremental). Binary code storage is via lines M10, M11 and M12, and memory retrieval (line R20 at "0"), via lines R10, R11 and R12, connected to the "precount" inputs of U45.

#### 3.6.2.- B1 trigger channel switching logic

Two cases must be considered :

##### a) Selected trigger source not "ALT" (input A0 of U43 at "0")

The selected trigger channel is enabled by one of the 6 outputs of U46, via U44 (MOS/TTL level converter), and multiplexer U43.



**b) "ALT" trigger source selected (input A0 of U43 at "1")**

To enable the trigger channels, multiplexer U43 is driven by the Y channel (A, B or C) switching signals, instead of the U46 outputs.

Output 7 of U47 is used to inhibit trigger channel B, leaving trigger channel A only, when channel Y is selected in the "A+B" mode.

**3.6.3.- B2 trigger source selection and switching**

The device is identical to that described above, but has no "line" trigger control. It comprises keyboard pushbuttons S15 and S16, incremental/decremental counter U39, demultiplexer U40, converters U41 and multiplexer U42. The outputs of U40 are inhibited by diodes CR71, CR72 and CR73, for the "XY", "B1 only" and "B2 starts" modes.

**3.7.- KEYBOARD FUNCTION STORAGE (Z1 - fig. 4)**

Circuits U7 to U11, and U12 to U16 comprise two separate sub-assemblies, each designed to store data defined at a given moment on the control keyboard, subsequently restoring this data on demand.

When an "0" level is applied to pins 9 and 10 of these circuits ("input control"), the data present on storage lines M1 to M19 (inputs 11 to 14) are transferred to internal flip-flops (transfer is on a clock signal applied to pin 7).

In other cases, the circuit inputs are disconnected, and the flip-flops are looped, holding the data in memory.

Likewise, when an "0" level is applied to pins 1 and 2 ("output control"), the stored data outputs on memory retrieval lines RM1 to RM20 (outputs 3, 4, 5 and 6). In other cases, the 3-state outputs are disconnected from the internal memories, and are at high impedance.

When pushbutton "M1" (or "M2") is pressed, data are transferred to memory by resetting inputs 10.

Memory retrieval is selected by pressing the "RCL" pushbutton (resetting inputs 1 via switch U18/11 and flip-flop U36), followed by "M1" (or "M2"), to reset inputs 2. The time separating these two operations is limited by constant R107-C56, which defines the turn-over time for U36 (holding input 10 at "0").

Recapitulation of storage and memory retrieval lines :

M1	RM1	"ALT"/"CHOP"
M2-M3	RM2-RM3	Y mode
M4-M5	RM4-RM5	"AUTO"/"NORM"/"SINGL SWP"
M6-M7	RM6-RM7	B1 trigger filter
M8	RM8	B2 "RUNS"/"TRIG"
M9	RM9	x1 or x10 horizontal gain
M10-M11-M12	RM10-RM11-RM12	B1 trigger source
M13-M14-M15	RM13-RM14-RM15	B2 trigger source
M16-M17-M18	RM16-RM17-RM18	X mode
M19	RM19	20 MHz bandwidth

Line RM20 is loaded into a resistance (R114) ten times weaker than the other lines, and is used to send a "memory retrieval" command to the various circuits, ahead of stored data.

### 3.8.- Y CHANNEL SWITCHING LOGIC (Z1 - fig. 8)

#### 3.8.1.- Switching program

PROMs U52 and U53 are associated with flip-flops U49a and U49b for control of sequential channel Y switching, and assignment of the delay (R1 or R2) for B2 sweep start, via outputs 9 to 12 of U53. The switching program is defined by the state of memory circuit address inputs A0 to A7, the function of these inputs being as follows :

- A0-A1 : Indicate the state of flip-flops U49a and U49b. These flip-flops are used in the divide-by-2, 3 or 4 counter mode, according to the number of channels used, switching mode and selected Y mode. Value of output Q2 (10) of U52 according to addresses A0 and A1 :
- Division by 2 :  $Q2 = \overline{A0}$   
 by 3 :  $Q2 = \overline{A0} \cdot \overline{A1}$   
 by 4 :  $Q2 = \overline{A1}$
- A2 : Receives the "ALT" function ("1" state) or "CHOP" function ("0" state).
- A3-A4-A5 : Receive the enable state ("0") or cancel state ("1") from the "ON" switches for channels A, B and C (fig. 20 and 23).
- A6-A7 : Receive the binary code corresponding to selected Y mode, sent via lines M2 and M3 (see paragraph 3.5.4).

### 3.8.2.- Switching modes

Dividers U49a and U49b can receive two types of signal on their clock inputs :

- "ALT" Y mode : short positive signal, via 4 of J2 and U51/8, corresponding to B1 end of sweep, with frequency corresponding to B1 or B1/2, depending on whether the selected X mode is normal or "ALT".
- "CHOP" Y mode : 1 MHz fixed frequency signal, via U48/11 and U48/8. The oscillator delivering this signal comprises U48/6 and U48/3. A mark space ratio substantially different from 1 makes it possible to obtain short positive pulses. These pulses are also used, via Q13, for trace blanking.

B1 on pin 9 of J2 inhibits the "chopped" signal in input 12 of U48, in the absence of a B1 sweep. The chopped signals only appear on output 8 of U48 after start of B1 sweep, to avoid triggering B1 on the "chopped" signal.

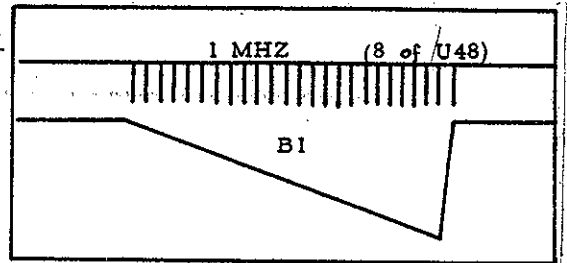

### 3.8.3.- PROM control functions

#### - U52 outputs :

- Q0 : "Sweep alternate" or "single sweep" ("chopped" > 1 channel = 1)
- Q1 : Counter held at zero (counting stopped) for "single sweep"
- Q2 : Imposes counter clock state (division-by-2, 3 or 4)
- Q3 : Controls "algebraic addition" function (A + B), significant state : "0"

#### - U53 outputs :

- Q0 : Channel A control, significant state : "1"
- Q1 : Channel B control, significant state : "1"
- Q2 : Channel C control, significant state : "1"
- Q3 : Assignment of delay for "ALT" Y mode and multi-channel modes (1 = delay 1, 0 = delay 2).

In the "chopped" or "single sweep" mode, Q3 is held at "1". U51/11 sends a delay change each time U50 turns over (B1 or B1/2 for normal or "ALT" X mode).

### 3.8.4.- Calibrator

The 1 kHz signal delivered by oscillator U17/12 is used for probe adjustment (front panel output J801), and as a clock signal for keyboard selection storage (fig. 4).

ASSIGNMENT OF DELAY 1 (R1) AND DELAY 2 (R2) (See fig. 8)

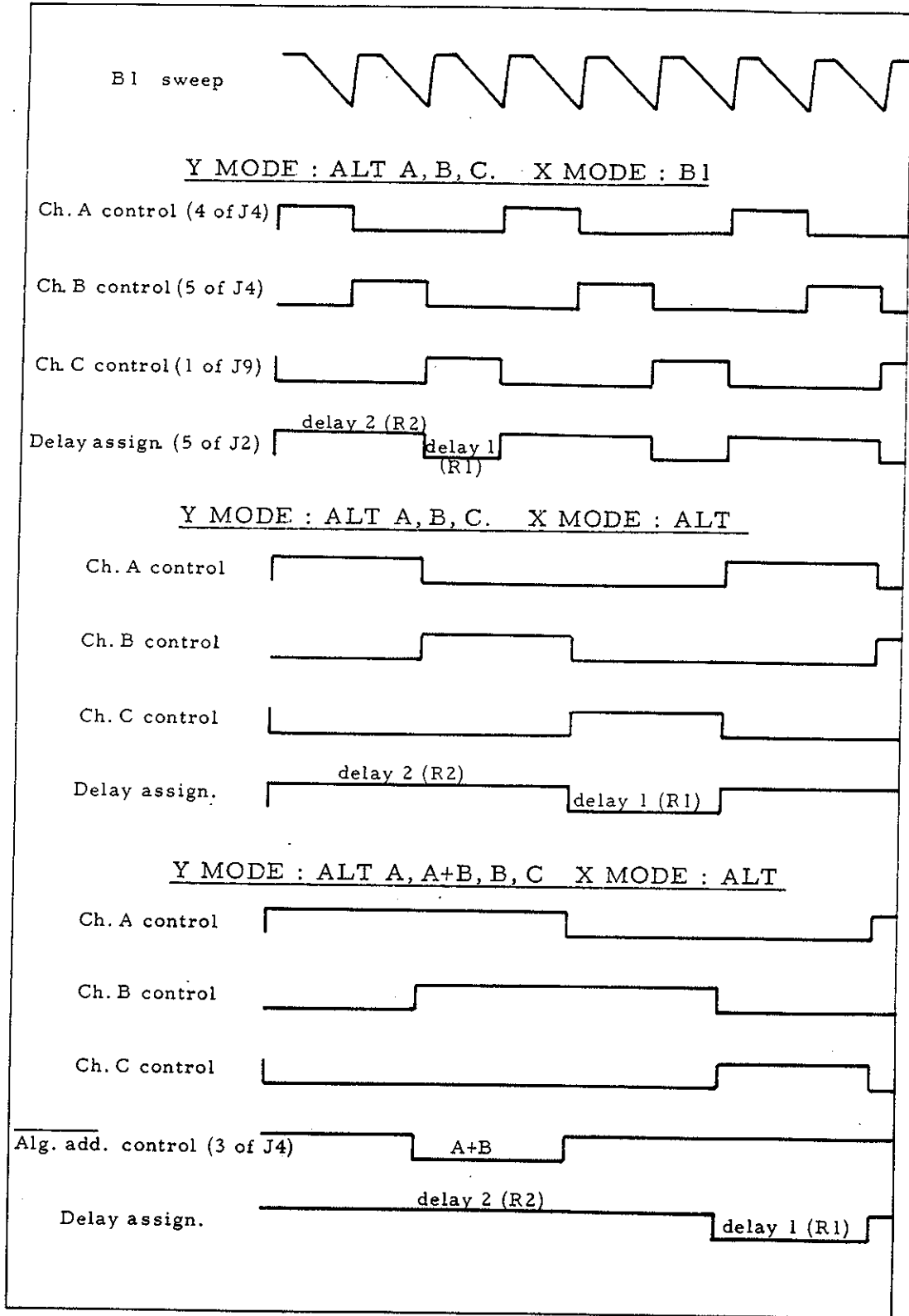

NOTE : - "Chopped" mode : no delay assignment  
 - "Sweep Alt" mode :  
     . with channel C : R1 on channel C, R2 on channels A and B  
     . no channel C : R1 on channel A, R2 on channel B

### 3.9.- TRIGGER SWITCHING (Z1 - fig. 9)

#### 3.9.1.- B1 Trigger

The command signals from the trigger logic (fig. 7) are used to select the signal from one of the following as trigger source :

- . channel A via Q26 and CR81 (CR80 cut off)
- . channel B via Q30 and CR86 (CR84 cut off)
- . channel C via Q28 and CR83 (CR82 cut off)
- . external trigger amplifier via Q24 and CR79 (CR78 cut off)
- . line power supply via Q22 and CR77 (Q21 cut off).

In the algebraic addition mode (A+B), only channel A is used for triggering, channel B being cut off by diode CR85.

The "chopped" signal is amplified in hybrid circuit A1, with negative feedback by R211, and is applied (sensitivity 100 mV/div.) to the B1 trigger circuit (Z2 - fig. 11), and the horizontal deflection amplifier in the XY mode (Z2 - fig. 16).

#### 3.9.2.- B2 trigger

This device is identical to that described above, and comprises, in particular, Q25 and CR90 (channel A), Q29 and CR95 (channel B), Q27 and CR93 (channel C), and Q23 and CR88 (external channel), together with control diodes CR91, CR94, CR92 and CR89.

The signal is amplified by hybrid circuit A2.

#### 3.9.3.- External trigger input

The signal from "External trigger" input J901 is attenuated by a factor of 10 (or not) in R221-R222, and applied to amplifier Q34-Q35 via FET Q33, before being sent to the trigger switch.

#### 3.9.4.- Y signal output

The channel B signal is also picked off ahead of the trigger switch, and is amplified by hybrid circuit A3 before being brought out on rear panel "Y signal output" connector J902.

### 3.10.- B1 - B2 TRIGGERING (Z2 - fig. 11)

#### 3.10.1.- B1 trigger filters

Before amplification and shaping, the B1 trigger signal follows two channels, via transistor Q3 for the HF arm, and amplifier U1 for the LF arm.

Both channels are used for the  $\sim$  and  $\overline{\sim}$  transmission modes. For the  $\sim$  mode, the DC component is filtered out by capacitor C4, connected in series in the LF channel. For the  $\overline{\sim}$  mode, this capacitor is shorted by transistor Q2.

In the  $\sim$  LF mode, the HF channel is not used, as Q3 is cut off by Q4, and capacitor C4 is also shorted in order to pass the DC component.

For the  $\wedge$  HF mode, the LF channel is cut off by grounding R4 via Q1.

#### 3.10.2.- Shaping and polarity

The B1 and B2 trigger signals are amplified and shaped (ECL) in identical hybrid circuits A1 and A2. In each case, one input (2) receives the trigger signal, and the other (3) receives the variable voltage signal from the "level" control.

On outputs 7 and 6, a switch (operated by the "level" control stem) is used to select triggering on the rise and fall edge of the trigger signal.

#### 3.10.3.- B1 "level" control operation in "automatic" and "triggered" modes

The operating range of B1 "level" control (R57) is defined by the output voltages of followers U3/1 and U3/7.

In the "TRIG" mode (2 of J6 at "0"), switches Q5 and Q11 are closed. The voltages delivered by U3/1 and U3/7 are fixed (0 V and + 5 V respectively).

In the "AUTO" mode (2 of J6 at "1"), Q5 and Q11 are cut off. The voltages delivered by U3/1 and U3/7 are no longer fixed, but follow the positive and negative peak values of the trigger signals, permanently. This is achieved by means of storage capacitor C15, charged at the negative signal peaks by U2/1 - U2/5 - Q7 - U2/14, and storage capacitor C16, charged at the positive signal peaks by U2/4 - U2/11 - Q8.

Triggering is thus genuinely automatic, as level control range is limited to signal peak-to-peak amplitude at all times.

Transistors Q9 and Q10 make it possible to use "level" control R57 for fine triggering adjustment of certain HF signals, by applying a slight modification to sweep hold-off.

#### 3.10.4.- "Automatic" flip-flop

Flip-flop U5 is associated with Q6, and functions as a monostable triggerable by the B1 trigger signals. Turn-over time is defined by constant R35 - C13, and reset (input R at "0") occurs after a delay defined by R38 - C13.

In the presence of trigger signals, the pulses available on output 2 of U5 are subjected to peak detection by CR7 - C14.

Storage capacity C14 is charged positively, and selects "TRIG" operation of the B1 timebase.

In the absence of trigger signals (or if signal frequency is below 25 Hz), C14 discharges to R33, and selects the "RUNS" sweep mode.

### 3.11.- B1 TIMEBASE (Z2 - figs 12 and 14)

#### 3.11.1.- Sawtooth generator

The sawtooth is delivered by a Miller integrator, comprising FET Q18, amplifier Q19, loaded by Q17, and RC elements connected to point L. These elements are selected by "B1 time/div." selector S1a, and multiplier U17 (fig. 14). A constant current applied to the terminals of resistor R combined with Q39 to constitute a constant current generator, charging capacitor C. The slope of this ramp (sweep rate is defined by the selected RC time constant (RR5 - R187 - R176 - R177 and capacitors C46 to C52), and the value of the Miller voltage. The low of this voltage, sent by follower U18/1, is adjustable by R178, R179 or R181 according to range.

This voltage can also be varied by R122, before it is applied to current generator U18/7 - Q39.

**3.11.2.- Sweep control**

Sweep is obtained when double bistable U9 goes low (output 15 at ECL "0" level). It receives the command signal :

. on input 13 (R at "1" selecting reset) in the "RUNS" mode. When a trigger signal appears on clock input 11 (if already reset on input 9) in the "TRIG" mode.

**Sweep triggering**

U9 is low and Q15 conducts into R102, cutting off diodes CR13 and CR14. The Miller amplifier charges capacitor C, delivering a decreasing voltage to point H.

**End of sweep**

When this voltage reaches + 4 V (low level) it actuates trigger U7/2. A short positive pulse on pin 5 of U9 resets this flip-flop to "1". Q15 is cut off, releasing diodes CR13 and CR14. The Miller capacity discharges and sawtooth flyback occurs.

**Flyback to initial voltage**

Differential amplifier U10 compares the sawtooth received on input 6, with a fixed initial voltage of + 12 V (defined by divider bridge R85 - R86, and applied via follower U8/6 to input 9 of U10). When the sawtooth reaches this value at end of flyback, transistor Q14 conducts into R102, thus looping the Miller integrator, output of which is still slaved to the initial voltage.

**3.11.3.- Hold-off**

At end of sweep, U9 turns over and Q15 is cut off, thus driving reset trigger U7/15 (high) via Q26 - Q25 - Q24 - Q23. This command signal is sent after a delay, introduced on the basis of Q23 by a hold-off capacitor. This capacitor is selected by multiplexer U16 (C54 to C58 - fig. 14) according to selected sweep rate. The capacitor is associated with R124, R123 and control R122, used to adjust hold-off time after flyback.

U7/15 goes to "0" at end of hold-off time, with the following results :

- . in the "triggered" mode, double flip-flop U9 is set by the common clock command (9). U9 turns over (output 15 at "0") when a trigger signal appears on input 11.
- . in the "runs" mode, U9 turns over immediately (RAO 13 at "1") via U7/14 (input 11 at "1").



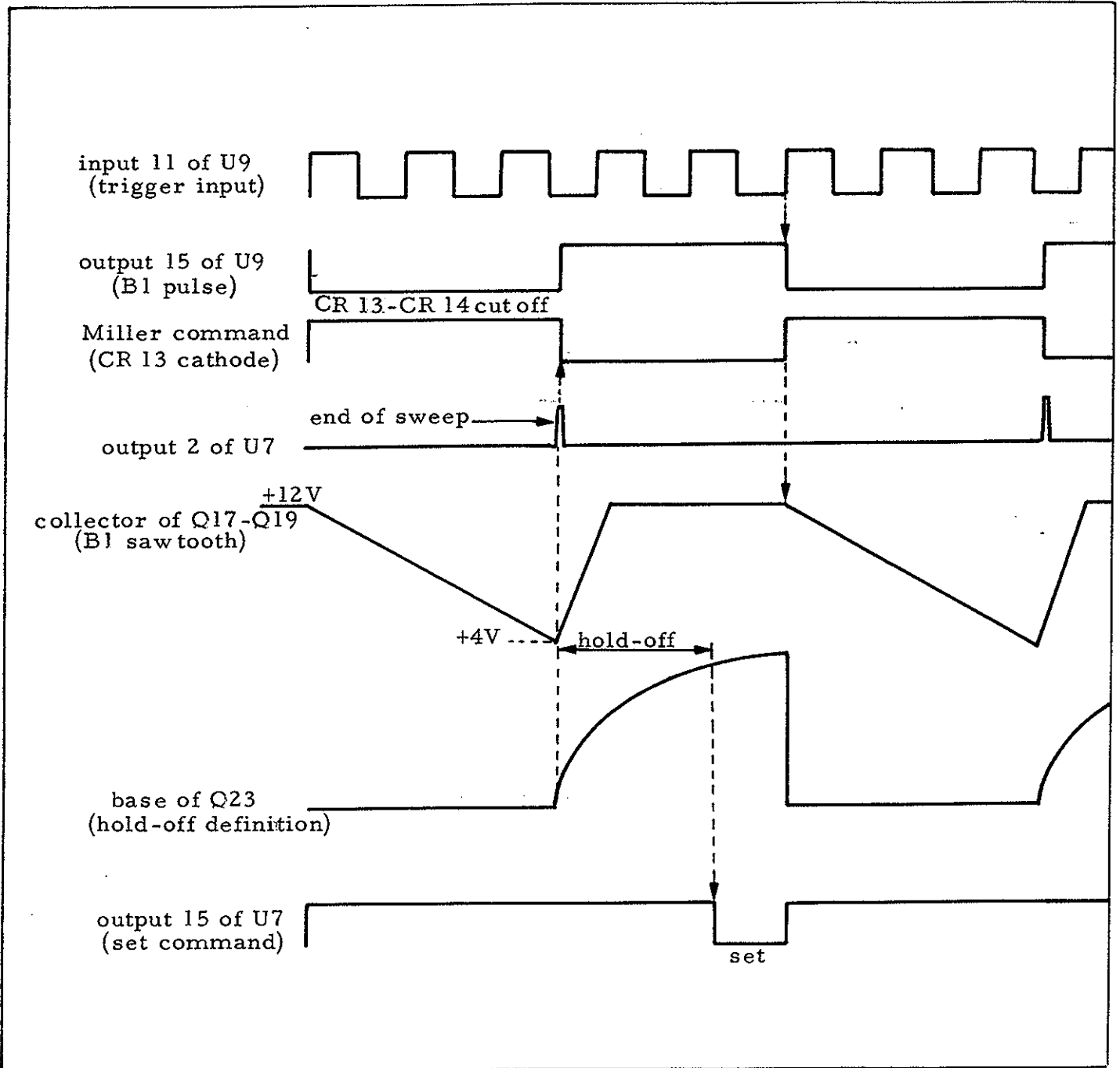

B1 "TRIGGERED" SWEEP

#### 3.11.4.- Single sweep

In the "single sweep" mode, transistor Q22 is cut off by a "0" level on pin 6 or J7. The collector voltage of Q22 is reduced, so that the current of Q23 is not sufficient to make U7/15 turn over on flyback, even when the hold-off capacitor is charged. There is no sweep reset.

When the "RESET" pushbutton is pressed, a short positive pulse is sent (via C71 and U25/2 - fig. 6) to the emitter of Q22, making U7/15 turn over and obtaining sweep reset (for one sweep only).

When U7/15 is awaiting reset, its output 15 drives the "SINGL SWP" lamp in the flashing mode, via Q20 and Q21, by a high on pin 7 of J7 (2 of J2 - fig. 6) (see paragraph 3.5.9).

#### 3.11.5.- B2 delay circuit

Differential amplifier U11 is used to control B2 sweep delay with respect to start of B1 sweep. It compares the B1 sawtooth applied to one input (9), with a DC voltage applied to its other input (6). This voltage can be adjusted, either on the "delay 1" control (fig. 19) via follower U28/1 (fig. 18), or on the "delay 1" and "delay 2" controls, switched by analog switches U12/R (R1) and U12/3 (R2).

When its two inputs coincide, comparator U11 delivers a negative edge on output 8. This is the delay signal sent by Q16, which sets or triggers B2 sweep (fig. 13).

### 3.12.- B2 TIMEBASE (Z2 - figs. 13 and 15)

#### 3.12.1.- Sawtooth generator

As for the B1 timebase, the generator comprises a Miller integrator incorporating FET Q35, amplifier Q36 loaded by Q33, and RC elements (point F) selected by S1b and multiplexer U19 (fig. 15).

The Miller voltage, adjustable by R196 or R197, is sent via U20/7, U20/1 and Q40.

### 3.12.2.- Sweep control

Start of sweep is controlled by double bistable U14 (output 15 at "1"), which cuts off diodes CR21 and CR22 via Q34.

U14 flops at end of sweep, driven by a pulse due to the current of Q29, which sets inputs 4 and 13 (reset) of U14 to "1".

The B2 pulse is sent to rear panel connector J1301 via Q37 and Q38.

### 3.12.3.- B2 "runs" or "triggered" sweep

The signal from the comparator, via U13/14 and U13/3, sets output 2 of U14 at "1" (input D is at "1" during the B1 pulse).

. In the "runs" mode (5 of J7 at "1"), U13/2 sends an "0" state to input 12 (set) of U14, with resultant turn-over (output 15 at "1") and immediate start of sweep.

. In the "triggered" mode U13/2 is cut off. B2 sweep only starts when a trigger signal appears on its clock input (11).

### 3.12.4.- B2 initial voltage

Miller integrator output is slaved to initial voltage by differential amplifier Q31 - Q32, powered by Q30. This voltage is applied to the base of Q31, and is fixed (+ 12 V) except in the "mixed" mode, in which case it follows the B1 sawtooth. Switching is by Q27 and analog switches U12/9 and U12/10. In the "mixed" mode, Miller integrator output (point G) copies the B1 sawtooth until the B2 sweep is triggered. When the B2 sweep is triggered, slaving to initial voltage terminates, and the ramp slope is then defined by the B2 timebase RC elements.

Flip-flop U15 is used in the "mixed" mode (input D at "1") to control trace blanking at end of B2 sweep.

### 3.13.- "X MODE SWITCHING - BRIGHT-UP CONTROL (Z2 - fig. 16)

The gates of U22, U23 and U25, together with two flip-flops U24, are used to switch the appropriate signal to the horizontal deflection amplifier, and simultaneously control the bright-up amplifier, according to X mode selection from the switching logic (via connector J6).

- 60 -

The signals to be switched can come from the B1 timebase, B2 timebase, or (XY mode) the Y channel selected for B1 triggering. The signals are sent by FET Q46, Q48 or Q50. Unused signals are shunted to ground by transistors Q45, Q47 and Q49.

Mixing of the bright-up pulses is by circuit U21, operating as a controlled current source. The four amplifiers of this circuit are cut off or released by inputs 5, 6, 11 and 12. They are controlled in the current mode (common base arrangement) by the signals received on outputs 2, 3, 14 and 15. The respective currents of these amplifiers are added on the common power supply of U21 (pin 1), and the resultant current is used to drive the bright-up amplifier via Q76.

**B1 mode** : (command "reset" of U24) U24/13 at "0" and U24/12 at "1". FET Q46 sends the B1 sawtooth. Amplifiers U21/2 and U21/3 are cut in, and power the B1 bright-up pulse.

**B2 mode** : (command "set" of U24) U24/13 at "1" and U24/12 at "0". FET Q48 sends the B2 sawtooth. Amplifier U21/14 powers the B2 bright-up pulse.

**B1 + B2 mode** : the B1 sawtooth is sent via Q46. The B1 bright-up pulse is powered by U21/2, and during the B2 sweep, U21/U15 is also in service and controls extra-bright display.

**Mixed mode** : Q28 first sends the B1 sawtooth (used as initial voltage for B2), with bright-up powered by U21/2. At end of delay, Q48 sends the B2 sawtooth, extra-bright display being obtained by U21/14. Transistor Q42 is used to control trace blanking at end of B2 sweep.

**XY mode** : R41 and R40 are enabled at the same time. Outputs 12 and 13 of U24 are both at "1", cutting off transmission of the B1 and B2 sawtooths. FET Q50 switches the signal sent by Q78 to the horizontal deflection amplifier. This signal is from the Y channel selected for the B1 trigger signal (2 of J8 - Z1 - fig. 9). Q13 controls bright-up by grounding R221.

**X ALT mode** : flip-flop U24b is driven on its clock input (11). U24b receives short positive pulses from U24a, corresponding to the end of the P1 pulse sent by Q44, and operates in the divide-by-2 counter mode. Outputs 12 and 13 of U24b are inverted on each sweep, switching the B1 sweep (with superimposition delivered by U21/15) and the B2 sweep alternately.

Front panel "B1 intensity" control R208 is cut in by analog switch U26/11, to allow reduction of B1 trace brightness as desired, by shunting part of the U21/2 current.

Gates U25/10, U25/3 and U25/4 send a short positive signal at B1 frequency, except in the "X ALT" mode in which case this frequency is divided by 2 (B1/2), to the Y logic (Z1 - fig. 8).

### 3.14.- HORIZONTAL DEFLECTION AMPLIFIER (Z2 - fig. 17)

The X mode selection signal is sent to stage Q51 - Q53 (Q53 receives the horizontal shift command on its base). The signal is then applied to differential stage Q54 - Q56, driven in the current mode by Q52, and balanced by R260. The gain of this stage is adjustable on R262. Gain can be multiplied by a factor of 10, by connecting R265 - R266 in parallel with the emitter resistors, using relay K1, controlled by the switching logic (fig. 5), for this purpose. "x10" gain can then be adjusted on R265.

The signal is sent to the output amplifier via differential stage Q55 - Q57.

Q55 is followed by an amplifier comprising Q58 - Q59 - Q63 - Q64, with voltage negative feedback by a loop comprising R290 - R291 - R292, follower Q65 and R296.

Symmetrically, Q57 is followed by amplifier Q61 - Q62 - Q67 - Q68, with negative feedback by loop R304 - R301 - R302 - Q66 and R299.

Transistors Q59 and Q61 are of the opposed type (to improve sawtooth transmission), with offset emitter voltages. Diodes CR25 and CR26 are used to compensate this voltage offset, and reference the emitters to a common point, the voltage of which is set by transistor Q60.

At output, the signal is sent to the X plates of the CRT via R289 and R306.

### 3.15.- VOLTMETER - $\Delta t$ - $\Delta$ DIV FUNCTIONS (Z2 - fig. 18)

#### 3.15.1.- Measurement principle

An ADC receives a DC voltage representing :

- . "volt" mode : input voltage to be measured
- . " $\Delta t$ " mode : voltage deviation defined by "delay 1" and "delay 2" controls
- . " $\Delta$  Div" mode: voltage with respect to ground, defined by the "TRACE SEP" control.

These three voltages are selected by analog switches U31.

The conversion operation consists in re-establishing the balanced state destroyed by the input voltage, by integrating successive basic electrical charges. These charges are delivered by clock pulses. A counter records the number of pulses required to re-establish the balanced state. This number represents the voltage applied at input, on converter output. On completion of conversion, and prior to reset for the next measurement cycle, counter content is stored for transmission, via multiplexed outputs, to a BCD/7-segment display decoder. The number displayed is directly proportional to input voltage value ("Volt" mode), time value (" $\Delta t$ " mode), or the vertical offset between the B1 and B2 traces on the screen (" $\Delta$  Div" mode).

### 3.15.2.- "Volt", " $\Delta t$ " or " $\Delta$ Div" selection

Flip-flops U33a and U33b, associated with gate U34/4, receive clock pulses from pushbutton S1 (Z3 - fig. 19). The selected mode is defined by a "1" level delivered in turn as follows :

1 of U33 at "1" : " $\Delta$  Div"  
 13 of U33 at "1" : " $\Delta t$ "  
 4 of U34 at "1" : "Volt"

Saturation of Q74 inhibits the " $\Delta t$ " mode when certain conditions (B2 "runs" mode, "B1 variable" control in "CAL" position, etc.) are not met.

### 3.15.3.- ADC

The voltage to be converted is applied to pin 3 of converter U39.

The natural sensitivity of this converter is defined by a reference voltage applied to pin 2. This sensitivity can be 2 V or 200 mV, according to the state of analog switches U37/4 and U37/2, controlled on pins 5 and 6 of U38 by the automatic range search circuit. For 2 V sensitivity, the reference is adjustable on R371, and integration time is defined by constant R364 - C96. For 200 mV sensitivity, the reference is adjustable on R372 and R364 is shunted by R363.

The converter generates its own clock pulses, clock pulse frequency being defined by resistor R365 (pins 10 and 11).

The count result is available (BCD) on multiplexed outputs Q0 to Q3 (20, 21, 22 and 23).

**3.15.4.- Automatic range search**

As measurement is cyclic, converter U39 delivers a positive pulse ("1" level) of about 5  $\mu$ s on its output 14, at the end of each counting cycle. During this pulse, converter outputs Q0 and Q3 indicate whether counter content is normal, in an overrange state ( $> 1999$ ), or indicating insufficient sensitivity ( $< 180$ ).

Q0	{	0 normal range
	{	1 overrange or insufficient sensitivity
Q3	{	0 overrange
	{	1 insufficient sensitivity

This data is used at the end of each counting cycle, for automatic switching of input attenuators and converter sensitivity, until the appropriate range is found.

The range search device comprises flip-flops U35b, U35a and U36a (receiving the pulse differentiated by C98 - R362 on their clock inputs), and gates U34. Automatic control at output is by the a' and b' signals (pins 13 and 1 of U35).

**Control logic**

Range 1 (highest sensitivity)	: a' = 0	b' = 0
Range 2	a' = 1	b' = 0
Range 3	a' = 1	b' = 1
Range 4 (lowest sensitivity)	a' = 0	b' = 1

**Overrange** : switch to next range on each counting cycle, until appropriate range found.

**Insufficient sensitivity** : switch to highest range, and proceed as for an overrange state.

**3.15.5.- "Volt" mode input**

The input voltage (J1901 - fig. 19) is applied to an attenuator (1/10, 1/100 or 1/1000), the high arm of which is R14 (fig. 19). The analog switches of U37, driven on their inputs 12 and 16 by the automatic range search circuit (a' and b'), ground the low arms of the attenuator (see below) :

1/10	attenuation : R355
1/100	attenuation : R355//R356-357
1/1000	attenuation : R355//R356-R357//R360/R361

The attenuated voltage is sent to input 3 of converter U39 via U31/2.

Commands		Attenuation	Converter sensitivity	Range
a'	b'			
0	0	1/10	0.2 V	1.999 V
1	0	1/10	2 V	19.99 V
1	1	1/100	2 V	199.9 V
0	1	1/1000	2 V	1999 V

### 3.15.6.- " $\Delta t$ " mode

#### Delay voltage selection

Followers U29/1 and U28/7 deliver two voltages (VR1 and VR2), defined by the "delay 1" and "delay 2" controls respectively (fig. 19). In the " $\Delta t$ " mode, transistor Q77 is cut off and gate U40/3 controls start of B2 sweep with delay 1 (U40/3 at "1"), or delay 2 U40/11 at "1"), according to the delay assignment command sent via Q75 and U40/4 (see analog switches U12/13 and U12/5 on fig. 12).

#### Input circuit

Voltages VR1 and VR2 are also sent to comparator U30, via a differential stage comprising U29 and transistors Q69 to Q73. Comparator U30 delivers a DC voltage at output, proportional to algebraic difference "VR1 - VR2". This voltage is then applied to an attenuator (1/1, 1/2 or 1/4), the high arm of which is R330. Two analog switches of U26, driven on inputs 13 and 5 by the "B1 time/div" selector (positions 2, 1, 5), ground the low arms of the attenuator (see below) :

position 1 (1/2 attenuation) : R331

position 5 (1/4 attenuation) : R334

In position 2, the switches are cut off and no attenuation is applied.

The voltage is then sent to input of converter U39 via U31/9.

**Note :** the attenuation factors (1/10, 1/100, 1/1000, etc.) imposed by the "time/div" selector, are reflected on the display by the corresponding decimal point position, and illumination of the appropriate "unit" lamp (ms,  $\mu$ s, ns).



**3.15.7.- "Δ Div" mode**

The voltage defined by "TRACE SEP" control R344 is matched to converter sensitivity by U32/1, and is applied to the converter via analog switch U31/10. This voltage is sent to the Y amplifier (fig. 26) every second sweep, via U32/7 by analog switch U26/8, driven by B1/2 signals on input 6. This makes it possible, in the "X ALT" mode, to shift the trace during the B1 sweep, but not during the B2 sweep.

**3.16.- DISPLAY (Z3 - fig. 19)**

The multiplexed converter outputs send counter content (BCD) to circuit U6, which is a BCD/7-segment decoder.

The 4 display digits (U1, U2, U3 and U4) come on in turn, on the command signals from U39 outputs 16, 17, 18 and 19 (fig. 18), via the buffer amplifiers of U5.

The segments are powered by the U6 decoder output bus. The vertical bar of the "+" sign is driven by output 22 of U34, via Q1.

Positioning of the decimal point (powered via Q2), and selection of the "unit" lamp are by a PROM circuit on Z2 (U42 - fig. 18). U42 is controlled via its address inputs by :

- . "Volt", "Δt", or "Δ DIV" selection (A7)
- . display multiplexing command (A0, A1)
- . automatic range search commands a' and b' (A2, A3)
- . position of "time/div" selector (A4, A5, A6).

**3.17.- CHANNEL A AND B INPUTS AND PREAMPLIFIERS (Z6-Z7 - figs. 20 and 21)**

Channels A and B are identical, and only channel A is described below.

**3.17.1.- Inputs (Z6 - fig. 20)****- Input impedance selection**

Selector S3 is used to ground resistors R2//R3. Input resistance then changes from 1 MΩ to 50 Ω.

### - Input coupling

The signal applied to input connector J2001 is transmitted by selector S2, either directly ("DC" position), or via capacitor C1 ("AC position). In the "0" position, attenuator input is disconnected from J2001 and grounded.

#### 3.17.2.- Attenuators (figs. 20 and 21)

The various contact combinations of selector S1 define the "V/DIV" vertical deflection factor.

High impedance input attenuator S1a (Z7 - fig. 20) defines attenuation factors of 1/1, 1/10 and 1/100.

Low impedance attenuator S1b, located at preamplifier output, defines attenuation factors of 1/1, 1/2 and 1/5. It is followed by control R59b.

Preamplifier gain can also be multiplied by 2 or 5, giving sensitivities of 5 mV/div and 2 mV/div from the 10 mV/div basic sensitivity (attenuator factor 1/1).

The following table shows selector contact status according to selected sensitivity (x = contact closed).

S1a										S1b					
	1	2	3	4	5	6	7	8	9	1	2	3	4	5	6
2 mV	X	X							X						X
5 mV	X	X						X						X	
10 mV	X	X								X			X		
20 mV	X	X									X		X		
50 mV	X	X										X	X		
. 1 V			X	X	X					X			X		
. 2 V			X	X	X						X		X		
. 5 V			X	X	X							X	X		
1 V			X			X	X			X			X		
2 V			X			X	X				X		X		
5 V			X			X	X					X	X		

### 3.17.3.- Preamplifier (Z7 - fig. 21)

The preamplifier stage comprises an HF amplifier, and a loop which slaves output to input to avoid drift, while providing for DC and LF transmission.

#### **HF amplifier**

The input signal is applied to FET Q1 via capacitor C17, giving very high input impedance. Q1 is powered in the current mode by transistor Q2. The value of this current acts on the bias voltage of Q1, and determines the DC level at HF stage output.

The signal is then applied to hybrid amplifier A1, via follower Q3. Global HF gain is 1 (adjustable on R36) for all sensitivities, with the exception of 5 mV/div for which gain is 2 (adjustable on R38), and 2 mV/div for which gain is 5 (adjustable on R40).

**Servo :**

The servo loop comprises two identical resistors R24 and R28, used to compare input voltage with output voltage (phase-opposed), and error amplifier U1. U1 acts on the bias of Q1 via Q2, thus slaving output of amplifier A1, which faithfully follows DC and LF variations at input.

For 5 mV/div or 2 mV/div, as gain is multiplied by 2 or 5, the output voltage is divided by 2 (R49/R51) or 5 (R49 - R52) before being compared with input voltage.

**Internal trigger signal**

The internal trigger signal is picked off via R61, and applied to hybrid amplifier A2.

**3.18.- CHANNEL A AND B Y AMPLIFIERS (Z7 - fig. 22)**

Channels A and B are identical, and only channel A is described here. The first, double-stage symmetrical amplifier comprises transistors Q7 and Q8, used in the current generator mode, followed by negative feedback shunt stage Q9 - Q10. The vertical shift (R59a) command signal is applied at this point. The channel inversion command is only applied to channel B, but the selector (not used) is wired on channel A, to ensure complete symmetry between the two channels.

A second similar amplifier comprises low stage Q11 - Q12, used as a current generator, and the negative feedback high stage which is common to all channels (see Q29 - Q30 - fig. 24). The channel selection command is applied to the base of Q13 between these two stages. A high level shunts the signal to Q13, via CR7 and CR9 (CR8 and CR10 cut off). A low level cuts off Q13. Diodes CR7 and CR9 are then cut off, and the signal is sent to the common stage via CR8 and CR10 (fig. 24).

**3.19.- CHANNEL C (fig. 23)****3.19.1.- Input and attenuator (Z6)**

Input coupling selection is identical to that for channels A and B. Attenuator S9 has two positions only : direct (1/1) and 1/10 attenuation by R10/R11.

### 3.19.2.- Amplifiers (Z7)

High input impedance double FET Q21 sends the signal to balancer stage Q24 - Q25. The channel C vertical shift command signal is applied at this point.

The following amplifier is identical to that for channels A and B. It comprises current generator low stage Q26 - Q27, and the high stage common to the 3 channels (Q29 - Q30 - fig. 24). Channel selection is by diode network CR18 to CR21, driven by Q28.

The internal trigger signal is picked off output of Q21, and amplified by Q22 - Q23.

### 3.20.- COMMON Y AMPLIFIER (Z7 - fig. 24)

Stage Q29 - Q30 receives the signal from channel A, channel B or channel C, according to Y mode selection.

This stage is followed by a double stage amplifier (Q31 - Q32 - Q33 - Q34) similar to that described above.

Resistors R287 and R288 match amplifier output to delay line impedance.

In the "BW 20 MHz" position, relay K1 is used to connect capacitor C116, to reduce bandwidth to 20 MHz.

Circuit U3 compares the two outputs, to drive diode CR5 or CR6 (Z6), indicating trace shift.

### 3.21.- FINAL Y AMPLIFIER (Z8 - fig. 25)

The signal sent by the delay line is applied to double stage amplifier Q1 - Q2 - Q3 - Q4, similar to those described above. Diodes CR1 and CR2 are used in the varicap mode, associated with NTC resistor RT1, and provide an HF response temperature correction function.

CR3 and CR4 are decoupling diodes, which create a window in the case of high amplitude signals, outside which the signal is limited. This avoids saturation of the transistors of final stage Q7 - Q8 (which would have an adverse effect on response), while maintaining a wide dynamic operating range.

Final stage Q5 - Q6 - Q7 - Q8 is a conventional cascode amplifier, which delivers the vertical deflection signals to the Y plates of the CRT.

### 3.22.- Y ALGEBRAIC ADDITION - TRACE SEPARATION (Z7 - fig. 26)

#### 3.22.1.- Operating point hold for "A + B" algebraic addition mode

Diode network CR22 to CR25 (driven via Q35) is used to hold the operating point of the Y amplifier (Q29 - Q30 - fig. 24) constant, on switching from the single channel state to the "A+B" algebraic addition state.

In the single channel state, Q35 cuts off CR22 and CR24. Diodes CR23 and CR25 conduct, and supply the amplifier with a current which is added to that from the selected channel (A, B or C).

To compensate for the increase in current which occurs in the "A+B" mode, an "0" state on pin 11 of J1 makes Q35 conduct, cutting off diodes CR23 - CR25, the current of which is thus deleted. The common Y amplifier input current thus remains constant.

#### 3.22.2.- Trace separation

In the "X ALT" mode, differential amplifier Q36 - Q37 receives a DC voltage defined by the "TRACE SEP" control (see R344 - Z2 - fig. 18), during the B2 sweep (alternating with B1 sweep). This voltage is applied between the two inputs of the Y amplifier, and selects vertical shift of the B2 trace with respect to the B1+B2 trace.



#### 4.- MAINTENANCE

This instrument uses high voltages, and all precautions must be taken to avoid any risk of accident after removal of the cover.

This chapter is designed to provide the user with information enabling him to repair or readjust his oscilloscope where required (following replacement of a component, for example).

A complete calibration check must be carried out after every 1000 hours in service.

##### 4.1.- MAINTENANCE OF THE FRONT PANEL

The front panel can become soiled as the result of frequent utilization. To clean, unscrew the operating knobs on the controls and contactor switches, and wash the engraved plate with soapy water or paraffin. No products with a petroleum, trichlorethylene, benzene or alcohol base must be used for this operation, at the risk of damage to the paintwork and printed markings.

##### 4.2.- ACCESS TO INTERNAL ELEMENTS

###### 4.2.1.- Removal of covers and handles

The upper cover can be removed by undoing the 4 lateral attachments screws. The lower cover is fixed to the frame by 4 screws which must also be removed.

The oscilloscope handle is integral with the lower cover, each pivot tab being fixed by 2 Allen screws.

###### 4.2.2.- Removal of Y mode sub-assembly (Z7, left side)

- Remove all the control knobs on the left part of the front panel. Undo the 7 printed plate attachment screws, and remove the panel.
- Remove the 2 front panel circuit attachment screws.
- Unsolder the "EXT TRIG" connector wire and ground connection.



5228 OSCILLOSCOPE

- 72 -

View 1

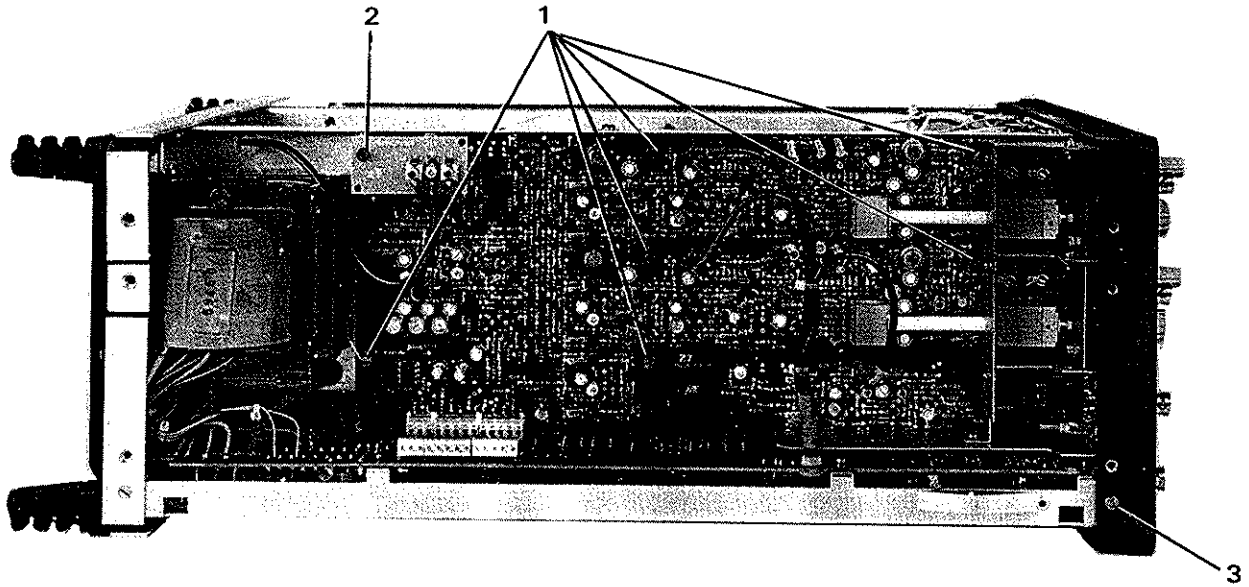

View 2

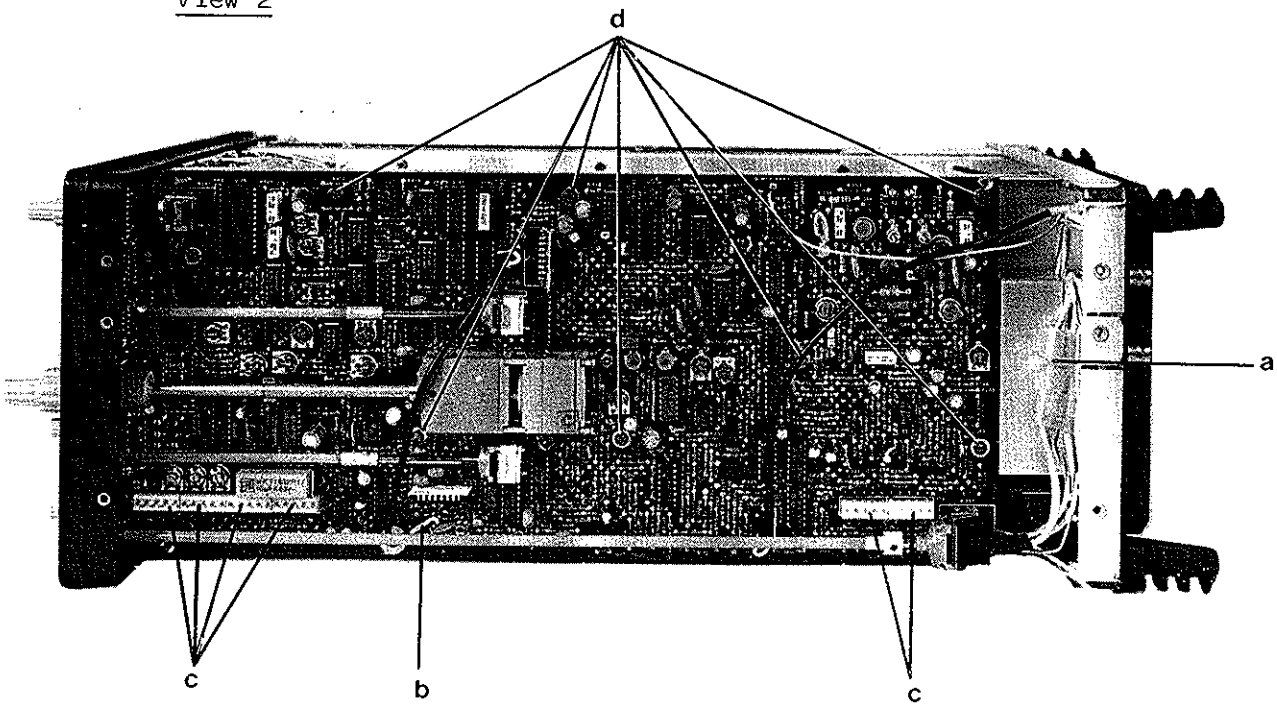

- 73 -

- Disconnect the blue wire connecting J18 ("CAL") on circuit Z1, to the front panel calibrator output.
- Disconnect the black input housing for the 3 coaxial "trigger" cables from card Z7.
- Disconnect the terminal strips (connector J1) connecting Z7 to card Z1.
- Extract the 6 attachment screws marked ① on view 1 (page 72).
- Extract card Z10, after removing the screw marked ② (view 1), and undo the pillar mounted on Z7.
- Then extract card Z7 rearwards. Take care to collect the small white plates surrounding the "DC 0 AC" switches.

#### 4.2.3.- Removal of X mode sub-assembly (Z2, right side)

- After taking off the caps, remove the control knobs from the right part of the front panel. Undo the 5 screws attaching the printed plate (4 Phillips screws in corners, and 1 RH screw).
  - Undo the attachment nut for the ground terminal behind the front panel and card, and unsolder the 9 MΩ resistor from the "Volt" input.
  - Remove the printed plate.
- Note :** Take care not to slacken off the "time/div" selector stem sleeve locking insert, as this adjustment is extremely delicate.
- Disconnect the white/green wire between the "B2 rear panel output" on Z2, and the "B2" output on the rear panel.
  - Disconnect the black wire between Z2 and the "B1" output on the rear panel, and the 2 black wires connecting with circuit Z1.
  - Disconnect the white line supply socket ( ③ on view 2) behind the power switch.
  - Disconnect the 6 terminal strips ( ④ on view 2), connecting with card Z1 : J6 (2 x 5 pins), J7 (2 x 5 pins), J8 (5 pins) and J15 (5 pins).
  - Undo the 7 card attachment screws (marked ⑤ on view 2).
  - Carefully disconnect pins X1 and X2 from the CRT connector, by raising the card.

View 3

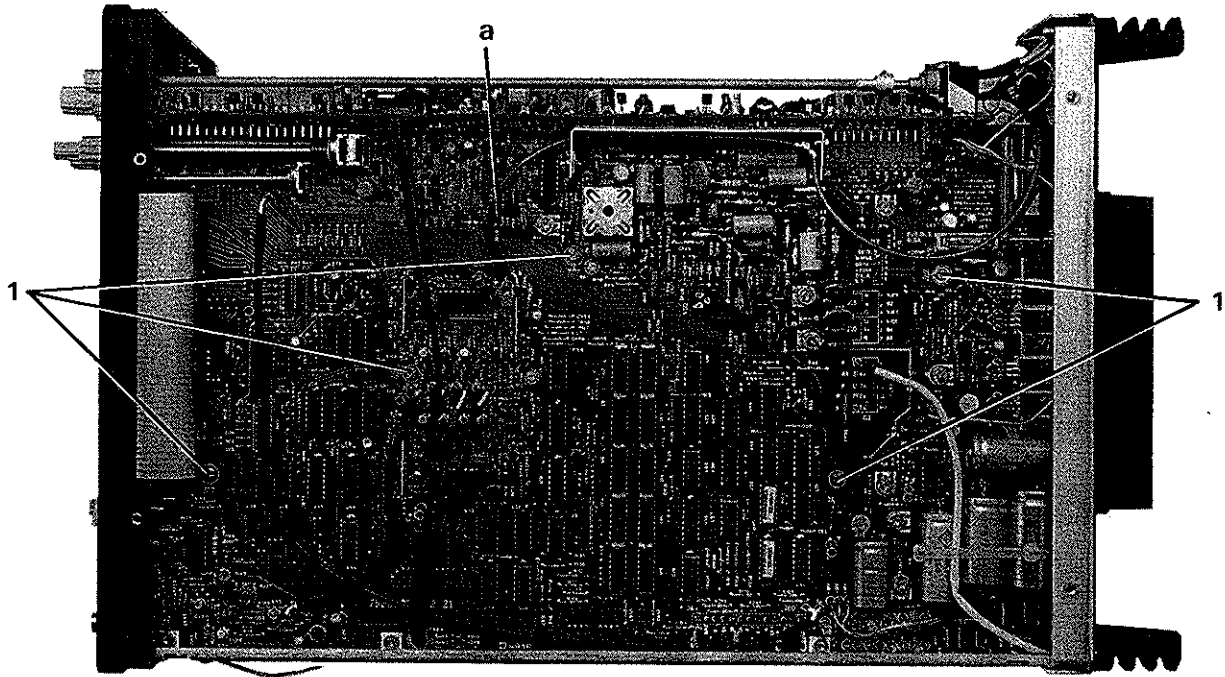

View 4

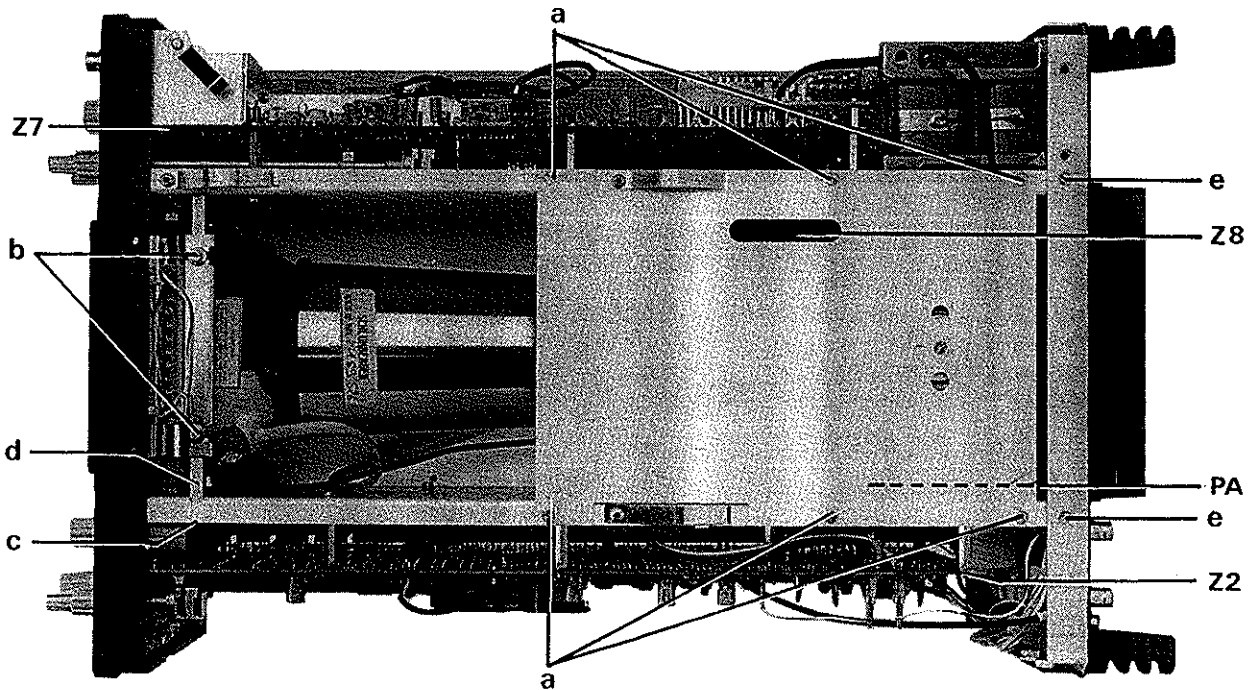

- 75 -

- Unsolder the 2 wires connecting the horizontal plates on circuit Z2 (marked X1, X2 on Z2).

- Remove card Z2, associated with front panel circuit Z3, extracting rearwards.

#### 4.2.4.- Removal of power supply sub-assembly (Z1, lower card)

Card Z1 can only be extracted coupled to the rear panel.

- Remove the "intensity" and "focus" knobs from the front panel.

- Undo the 2 Phillips screws fixing the keyboard card behind the front panel, and disengage the keyboard card rearwards.

- Undo the 5 attachment screws marked (1) on view 3.

- Disconnect the black input housing for the 3 coaxial "trigger" cables, and the blue wire to the front panel "┐┘.5 V" connector.

- Disconnect the 3 black wires from Z2, and the white/green wire connecting Z2 to the rear panel.

- Disconnect (Z2 end) terminal strips J6 (2 X 5 pins), J7 (2 x 5 pins), J8 (5 pins) and J15 (5 pins), and (Z7 end) terminal strips J1 (2 x 5 pins and 1 x 3 pins).

- Disconnect the white line supply connector ( (a) - view 2), at the rear of the power switch.

- Extract the flange / delay-line system. (6 screws marked a view 4).

- Extract the 2 screws fixing the bracket CRT base.

- Extract the CRT base and bracket sub-assembly and separate the

- Undo the 2 CS screws on the upper edge of the rear panel (marked (a) on view 4), 2 screws on either side of the heatsink (inside at top), and 2 screws on the outside of the heatsink.

- Uncouple the CRT Berg connector.

- Disconnect the red wire from the PDA package ( (e) on view 4).

- Undo screw (3) (view 1) in the anchor section for circuit Z1.

- 76 -

- Unsolder the wires connecting card Z1 to the "EXT TRIG" input, and the "CALIBRATOR" terminal (blue wire) on the front panel.
- Uncouple connector on Z8.
- Extract the Z1/rear panel sub-assembly rearwards.

#### 4.2.5.- CRT disassembly

- Detach the black screen masking plate from the front panel (1 screw under plate) and the blue neutral filter.

- From the front the oscilloscope, slacken off the four lock-nuts and undo the alignment jacks.

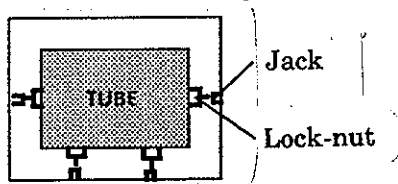

- Extract the 2 screws (marked (b) view 4) fixing the graticule illumination, extract the screw (marked (c) view 4) fixing the transverse rod (marked (d) view 4) and remove the system.
- Extract the 6 screws (marked (a) view 4) and remove the bracket and delay-line system.
- Uncouple the vertical plates card Z8.
- Unsolder the 2 wires horizontale plates marked X1, X2 on Z2 (this 2 wires are fixed with the CRT).
- Extract the 2 screws fixing the bracket CRC base.
- Push the CRT onward.
- Disjoin the bracket CRT base system
- Disconnect J17 on Z1 located on the rear CRT.
- Disconnect the PDA package from the CRT (carefully at the residual charge CRT).
- Get out the CRT shield assembly onward.

#### 4.2.6.- CRT reassembly

- Place the shield on the tube. Put correctly the horizontal and vertical plates outputs.
- Position the wires of the trace rotation coil backwards the tube and on the opposite side of the outputs plates.
- Connect the horizontal plates to the wire fixed on the shield.
- Position the base CRT in the rear tube bracket (the base CRT locating pin must be at the top).
- Put the shield tube assembly forward.
- Plug the base CRT and bracket in the rear shield.
- Connect J17 on Z1.
- Position the bracket tube on the chassis with 2 screws (don't tighten).
- Pass the horizontal plates wires through the chassis on Z2 and solder the wires on X1 X2 outputs of Z2.
- Connect the CRT vertical plates to Z8.
- Connect the PDA package.
- Replace the graticule illumination system.
- Position the front frame and push the CRT up to the front frame. Check that the tube is centred correctly and tighten the alignment jacks and the screws of the base CRT bracket.
- Replace the front masking plate and the blue neutral and fix the screws.
- Fix the bracket and delay-line system.

- Tighten the tube collar nut.
- Replace the front masking plate and the blue neutral filter, and fix the screw.

**4.2.7.- Removal of PDA sub-assembly**

- Extract the 4 screws fixing the PDA package to the oscilloscope frame.
- Disconnect red wire (f) from the PDA anode.

**4.2.8.- Removal of card Z8**

- Extract the 3 screws fixing Z8 to the frame.
- Disconnect the 2 white wires to the tube.
- Unsolder the white wire.

**4.2.9.- Removal of graticule illumination system**

- Remove the black screen masking plate (1 screw under masking plate), and the blue neutral filter from the front panel.
- From the front, slacken off the lock nuts and alignment jacks, on each side and under the tube.
- Remove 2 screws (b) (view 4) and extract the graticule illumination system.
- Raise the transparent line diffuser to change the lamps. Unsolder the old lamps, and solder up the replacement lamps.

**4.3.- EQUIPMENT REQUIRED FOR REPAIR AND ADJUSTMENT OPERATIONS**

INSTRUMENT	CHARACTERISTICS
- Test oscilloscope with probe	Bandwidth 100 MHz
- Digital multimeter	Display capacity : 1999
- Function generator type 4430	
- Time-calibrated signal generator	Range : 0.5 s to 1 ns
- Fast pulse generator type GI 643 B, with 50 $\Omega$ adaptor	Amplitude : 20 mV, 50 mV, 100 mV Rise time : 1 ns + flat top Repetition frequency : 100 Hz to 1 MHz
- Amplitude-calibrated square- wave signal generator	Internal impedance : 50 $\Omega$ or 1 M $\Omega$ ; amplitude : 50 mV at 20 V accuracy : 1% ; repetition frequency : approx. 1 kHz
- High amplitude pulse generator	Amplitude : 500 mV to 20 V ; pulse width : approx. 10 $\mu$ s.
- Standard voltage generator	Max. voltage : 1000 V
- Frequency multiplier with high stability output	0 to 250 MHz



**4.4.- ADJUSTMENT**

The operations described below must be executed in the logical and functional order shown. For all conformance checks, refer to the "Technical Specifications" section of the User Manual.

**4.4.1.- Power supply****- LV (Z1 - fig. 2 - Plate P3)**

- . Adjust the + 15 V on R12
- . Check the - 15 V (+ 2%)
- . Adjust the + 5 V on R31
- . + 45 V on R7
- . + 120 V on R3
- . Check the unregulated + 20 V (on fuse F1).
- . Check the back-up voltages :

- V1 (cathode of CR61) : + 15 V - V diode
- V2 (cathode of CR60) : + 15 V - V diode
- With the oscilloscope switched off, check that V1 = + 2 V
- Check voltage between anode and cathode of CR62 : 0.5 V

. Check noise on regulated power supplies ( $\leq 10$  mV) and check line power regulation in accordance with specifications.

**- HV and bright-up (Z1 - fig. 3 - Plate P3)**

- . Adjust CRT cathode voltage to 1755 V on R44 (pin K of JR11).
- . For B1 sweep, and with the "intensity" control at its minimum setting, observe the bright-up pulse on R100, and adjust the pulse load to + 5 V on R95.
- . In the triggered mode with no sweep, and with the "intensity" control in its maximum position, adjust the pulse load to +20 V on R79. Bring the trigger point to the limit of visibility on the screen, adjusting on R81.
- . In the "auto" mode, "B1 + B2" and with the "intensity" control in its maximum position, observe the bright-up pulse on the anode of CR23, and check the pulse does not exceed the grid current amplitude limit (alteration of B2 flat top).
- . Check bright-up at high sweep rates for the "B1", "B1 + B2", "B2" and "mixed" modes.
- . In the X "ALT" mode, check the action of the " $\Delta$  B1 intensity" control (front panel).

- CRT (Z1 - fig. 3 - Plate P3)

. **Trace rotation** : adjust sweep horizontality on R74 ("ROT" control on front panel)

. **Screen voltage** : adjust voltage to 28 V on R71 (Pin 1 of J16)

. **Focus and astigmatism** : adjust R70 for obtain the finest trace on all parts of the screen.

. **Geometry** : apply a sine-wave signal with vertical sweep covering screen height and horizontal scaling of 1 cycle / division. Adjust R72 for best sine waveform.

**4.4.2.- Vertical deflection (Z7 - Plate P5)****- Channel A**

. Select 2 mV/div and DC coupling, and balance input current on R27 (fig. 21). The trace should not shift when input is grounded and degrounded.

. Operation of vernier R59a should not cause any trace shift.

. Centre the range of the front panel vertical shift control, and that of R120, and bring the trace to the centre of the graticule by adjusting R131 (fig. 22).

. Apply a 1 kHz pulse to input A, and adjust LF gain to obtain a horizontal plateau :

10 mV on R36 (fig. 21)

5 mV on R38 (fig. 21)

2 mV on R40 (fig. 21)

. With a calibrated signal at input ("1 M $\Omega$ " and 10 mV/div), adjust channel A gain on R149 (fig. 22).

**- Channel B**

Adjustments are similar to those for channel A.

. Balance input current on R73 (fig. 21)

. Balance vernier R105b on R170 (fig. 22)

. Balance between normal and "inverted" position on R164 (fig. 22)

. Centre channel B trace on R165 (fig. 22)

. LF gain : 10 mV on R82 (fig. 22)

5 mV on R84 (fig. 22)

2 mV on R86 (fig. 22)

. Adjust channel B gain on R193 (fig. 22).

**- Channel C**

With a calibrated signal at input (0.1 V/div), adjust channel C gain on R236 (fig. 23).

## - Pulse response

**Note** : The following settings are obtained by successive partial adjustments. They are delicate, and require a good level of technical experience. In the "CAL" position, apply pulses with a frequency of 10 kHz (GI 634 B generator) at input. Adjust the following constants to obtain a pulse with minimum pulse-top irregularities (aberrations of the order of  $\pm 5\%$ ) :

<b>Channel A preamplifier</b> (50 $\Omega$ - 10 mV/div) (figs. 21 and 22)	R44 R136-C54 C58
<b>Channel B preamplifier</b> (50 $\Omega$ - 10 mV/div) (figs. 21 and 22 C71)	R90 R180-C67
<b>Channel C amplifier</b> (0.1 V/div) (fig. 23)	R224-C86 C139 C89
<b>Common Y amplifier :</b> (Z10)	R264-C101 R265-C103 R266-C104 R261-C99 R301-C138
<b>Line matching</b> (Z10)	L1-L2 G1
<b>Final amplifier</b> (Z8 - fig. 25 - Plate P2)	R15-C6 C10
<b>- Attenuator correction</b> (plate P5)	

Connect a high amplitude pulse generator at input (frequency 1 kHz, pulse width 20  $\mu$ s), and execute the following adjustments to eliminate pulse defects on the screen :

Sensitivity	Channel A (Z7-fig.20)	Channel B (Z7-fig.20)	
0.1 V/div	C3	C11	(1/10 atten. : 0.1 V to 0.5 V/div)
1 V/div	C5	C14	(1/100 atten. : 1 V to 5 V/div)

. Channel C : select 1 V/div and adjust C5 (Z6 - fig. 23).

**4.4.3.- Triggering****- Trigger channel centering**

Connect a voltmeter to B1 trigger coaxial input (Z2 - point b on plate P4) and execute the following adjustments to obtain 0 V :

- . Channel A trigger : R68 ( Z7 - fig. 21 - Plate P5)
- . Channel B trigger : R11 ( Z7 - fig. 21 - Plate P5)
- . Channel C trigger : R214 (214 - fig. 23 - Plate P5)
- . External trigger : R226 (227 - fig. 9 - Plate P3)

**- B1 trigger centering  $\sim/\overline{\sim}$** 

Select B1 trigger,  $\sim$  and NORM : display a sine-wave on the screen, and use the "B1 level" control to bring start of sweep to the centre of the signal. Then select  $\overline{\sim}$ , and bring start of sweep to the centre of the graticule by adjusting R9 (Z2 - fig. 11 - Plate P4).

**- Signal output centering**

With no signal applied to channel B, adjust R203 (Z1 - fig. 9 - plate P3) to obtain 0 V on rear panel output J902.

**4.4.4.- Horizontal amplifier (Z2 - Plate P4)****. Final X amplifier centering**

Select "x1", and connect the 2 probes of the test oscilloscope to the X1 and X2 plates, and centre the 2 signals (phase-opposed) by adjusting R277 (fig. 17)

**. x1 gain**

Select "x1", B1+B2, B2 RUNS and !t mode : turn the "delay 1" control fully anticlockwise, and the "delay 2" control fully clockwise. Adjust the difference between delay 1 and delay 2 to 10.5 divisions on R262 (fig. 17).

Adjust gain in the "XY" mode on R413 (fig. 16).

**4.4.5.- Timebase (Z2 - Plate P4)**

Use the time-calibrated signal generator to adjust the different sweep rates (1 pulse per division) in the order shown.

**B1 sweep**

- . Adjust the 10  $\mu$ s/div sweep rate on R181 (fig. 14).
- . With the same sweep rate, adjust x10 gain on R265 (fig. 17).

. x1/x10 centering : select x10 and 10  $\mu$ s on the generator. Shift the sweep horizontally, bringing the 6th pulse to the exact centre of the graticule. Select x1. Bring the 6th pulse to the centre of the graticule, adjusting on R260 (fig. 17).

- . Adjust 50 ns/div sweep rate on C49 (fig. 14).

. Adjust linearity at the high sweep rates, by successive partial adjustments as follows :

- 5 ns/div (50 ns, x10) : C79 and C84 (fig. 17)
- 2 ns/div (20 ns, x10) : C82 (fig. 17)
- 1 ns/div (10 ns, x10) : R303 (fig. 17)

- . Adjust 0.1  $\mu$ s/div sweep rate on C46 (fig. 14).

**Note** : All the above adjustments must be made by successive partial adjustments (R181, C49, linearity, C46).

- . Check sweep rates : 10-20-50 ns/div  
0.1-0.2-0.5  $\mu$ s/div  
1-2-5-10-20-50  $\mu$ s/div

- . Adjust 0.1-0.2-0.5-1-2-5 ms/div sweep rates on R178 (Fig. 14).

- . Adjust 10-20-50 ms and 0.1-0.2-0.5 s/div sweep rates on R179 (fig.14).

. Adjust minimum hold-off time :  
select 10 ns/div, and observe the sawtooth on the test oscilloscope. With the "HOLD-OFF" control turned fully anticlockwise ("CAL" position), adjust R123 (fig. 12) to obtain minimum hold-off time.

**B2 sweep**

. Adjust 10  $\mu$ s/div sweep rate on R297 (fig. 15), and check the 20-50  $\mu$ s and 0.1-0.2-0.5 ms/div sweep rates.

- . Adjust 50 ns/div sweep rate on C66 (fig. 15)
- 20 ns/div sweep rate on R139 (fig. 15)
- 10 ns/div sweep rate on R76 (fig. 15)

Execute these adjustments by making a number of successive partial adjustments.

- 86 -

. Adjust 0.1  $\mu\text{s}/\text{div}$  sweep rate on C61 (fig. 15), and check sweep rates from 0.2  $\mu\text{s}$  to 5  $\mu\text{s}/\text{div}$ .

. Adjust 10 ms/div sweep rate on R196 (fig. 15), and check sweep rates from 1 ms to 50 ms/div.

#### 4.4.6.- Voltage measurement (Z2 - fig. 18 - Plate P4)

Apply the voltage signals from a standard to the "volt" input, and obtain correct display of input voltage, referring to the following table :

Input voltage	Adjust
19.99 V	R371
1.999 V	R321
199.9 V	R356
1000 V	R360

#### 4.4.7.- $\Delta t$ mode (Z2 - fig. 18 - Plate P4)

In the  $\Delta t$  mode, select B1+B2 (B2 runs), B1 sweep rate 10  $\mu\text{s}/\text{div}$  and B2 sweep rate 0.1  $\mu\text{s}/\text{div}$ .

Apply a signal from the time-calibrated signal generator (10  $\mu\text{s}$ ).

. Adjust the "delay 1" and "delay 2" controls so as to superimpose the two extra-bright parts on the central pulse. Use the "B2" mode to obtain increased accuracy.

. Adjust R329 to display 0.000.

Adjust the "delay 1" control to bring the extra-bright part onto the second pulse, and the "delay 2" control to bring the other extra-bright part onto the 10th pulse (8 divisions between the 2 extra-bright parts).

Adjust R325 to display 80.0  $\mu\text{s}$ .

Repeat these two adjustments.

#### 4.4.8.- $\Delta$ DIV mode

. In the  $\Delta$ DIV mode, select X "ALT" and adjust the "TRACE SEP" control and R298 (Z7 - fig. 26 - Plate P5), so that maximum deviation amplitude is 9 divisions.

. Apply 50 mV of signal in input A (5 div. on 10 mV/div.)

. Superimpose the "B1+B2" and "B2" signals, and adjust R342 (Z2 - fig. 18 - Plate P4) to display 0.00.

. shift the "B1+B2" and "B2" sweeps from 5 div. as the amplitude signal and adjust R343 (Z2 fig.18 Plate P4) to display 5.00.

. Check + and - operation.

6.- MECHANICAL PARTS LIST6.1.- REAR VIEW

Number	Designation	ENERTEC ref.
1	Standard feet	864 241 002
2	Horary counter masking plate	867 522 484
3	Printed rear panel	868 708 031
4	Ext. rear heatsink	876 024 048
5	Rubber stop	876 500 002

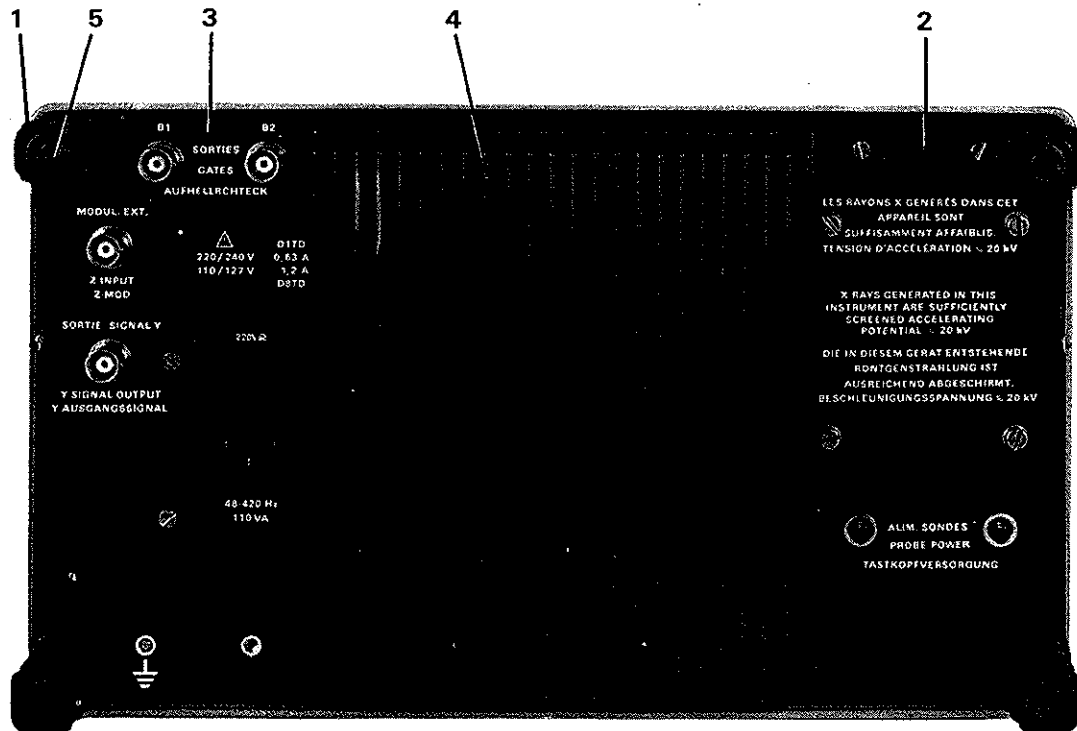



6.2.- FRONT VIEW

Number	Désignation	ENERTEC Ref.
1	Light grey 14,5 knob	219 623 331
	Light grey 14,5 cap	219 614 516
2	Grey 15 knob	219 621 344
3	Light grey 10 knob	219 621 231
	red 10 cap	219 614 592
4	Light grey 14,5 knob	219 621 331
	Light grey 14,5 cap	219 614 516
5	Light grey 14,5 knob	219 621 351
	Light grey 14,5 cap	219 614 516
6	Light grey 10 knob	219 621 231
	Grey 10 cap	219 614 590
7	Grey 10 knob	219 623 231
	Grey 10 cap	219 614 590
8	Time/div complete button	752 120 500
9	Contact button	874 041 026
10	M4 x 8 screw	309 104 008
11	Switch stem	862 554 105
12	CRT filter 8 x 10	859 541 005
16	Escutcheon	877 541 007
17	Y front panel - French version	866 700 253
	English version	866 700 262
18	X front panel - French version	866 700 256
	English version	866 700 265
19	Trig. front panel - French version	866 700 259
	English version	866 700 268

5228 PARTS LIST

6-3

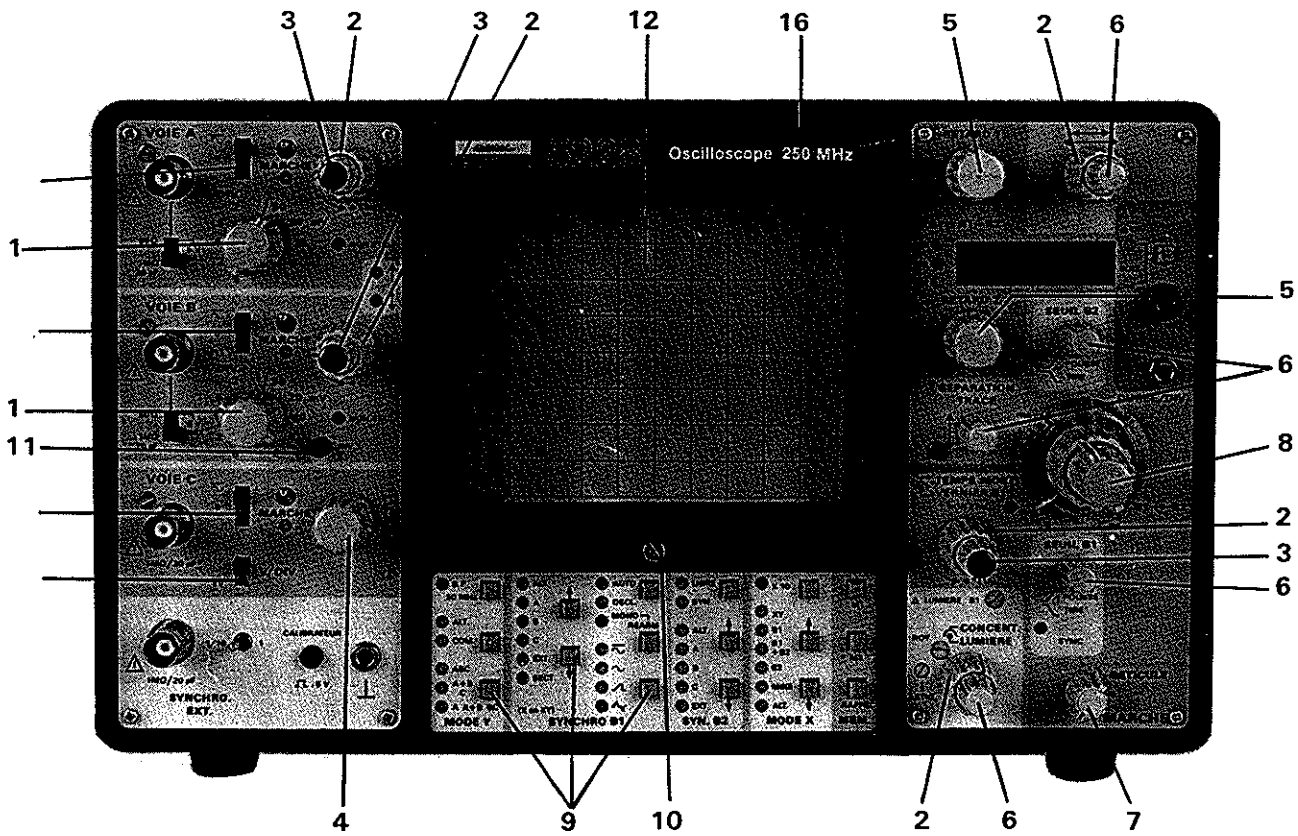

6.3.- LEFT SIDE

Number	Designation	ENERTEC Ref.
1	Rear shield bracket	841 012 252
2	Channels A and B Y input shield bracket	841 012 266
3	Shield bracket on Y circuit	841 012 267
4	Channels A, B, C Y input shield bracket	841 112 088
5	Ring grommet	253 507 450
6	Power supply circuit support bracket	841 112 078
7	Front panel	868 209 008
8	Plate spring	877 132 001
9	Ring grommet	253 507 460
10	Transformer TA69450	889 600 183

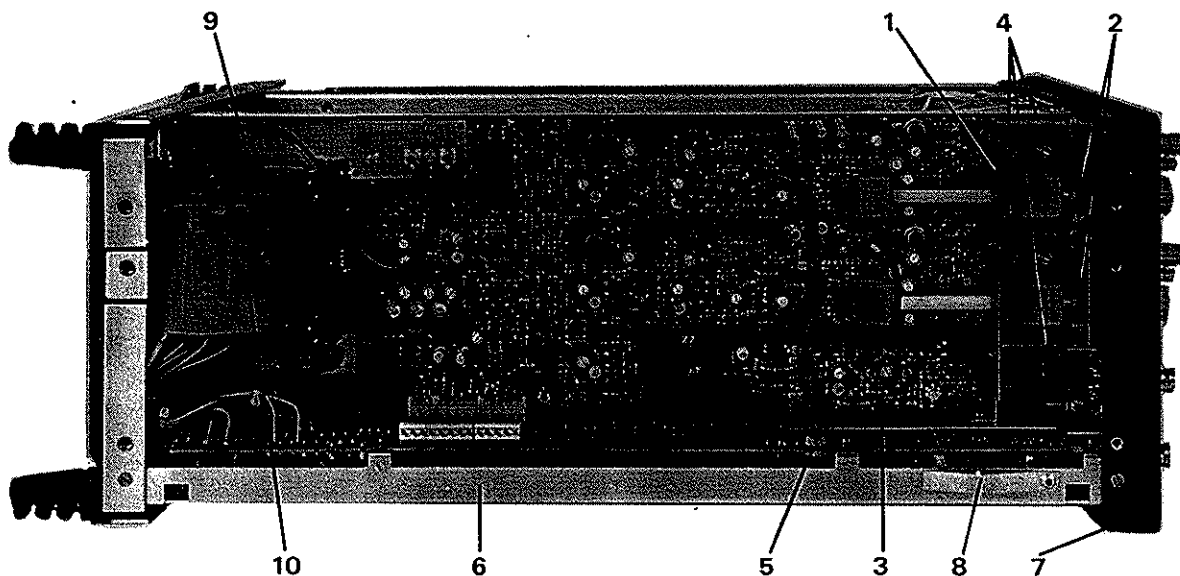

6.4.- RIGHT SIDE

Number	Designation	ENERTEC Réf.
1	Stem splicing sleeve	859 024 001
2	Prolongation stem	862 554 106
3	Card Z2 shield plate	867 532 091
4	Line protection	875 022 007
5	Pot. splicing sleeve	859 024 005
6	On/off pot prolongation stem	862 524 023

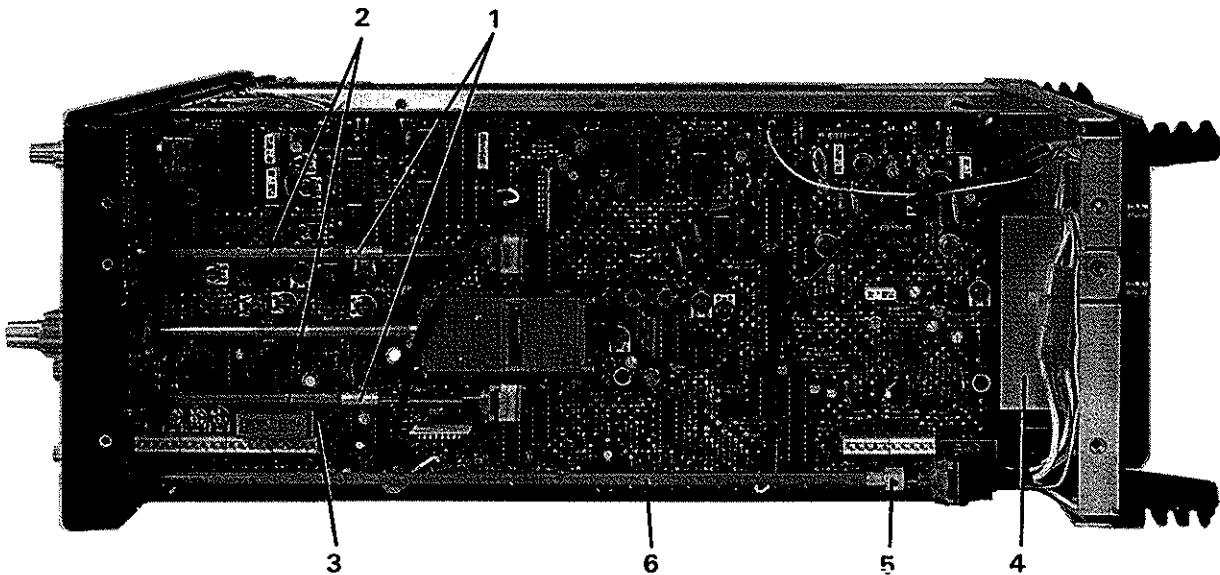

## 5228 PARTS LIST

6-6

6.5.- TOP VIEW

Number	Designation	ENERTEC Réf.
1	33 x 19 grommet	253 500 201
2	PDA box	752 280 603
3	CRT carrier bracket	841 222 021
4	CRT shield	871 512 053
5	Rear shield carrier	201 400 052
6	Front shield carrier	201 400 051
7	Hexagonal spacer 5,5 x 18 M3	345 083 180
8	Hexagonal spacer 5,5 x 20 M3	345 083 200
9	Y output amp. heatsink plate	867 522 507
10	Delay line spacer	845 024 115
11	Lower delay line flask	847 022 122
	Higher delay line flask	867 522 605
12	Centering jack	831 134 001
13	Main frame	832 222 049
14	Spacer M3	845 134 052
15	Plate spring	877 132 001
16	Hexagonal spacer 5,5 x 30 M3	345 083 300
17	Bus	873 904 022

5228 PARTS LIST

6-7

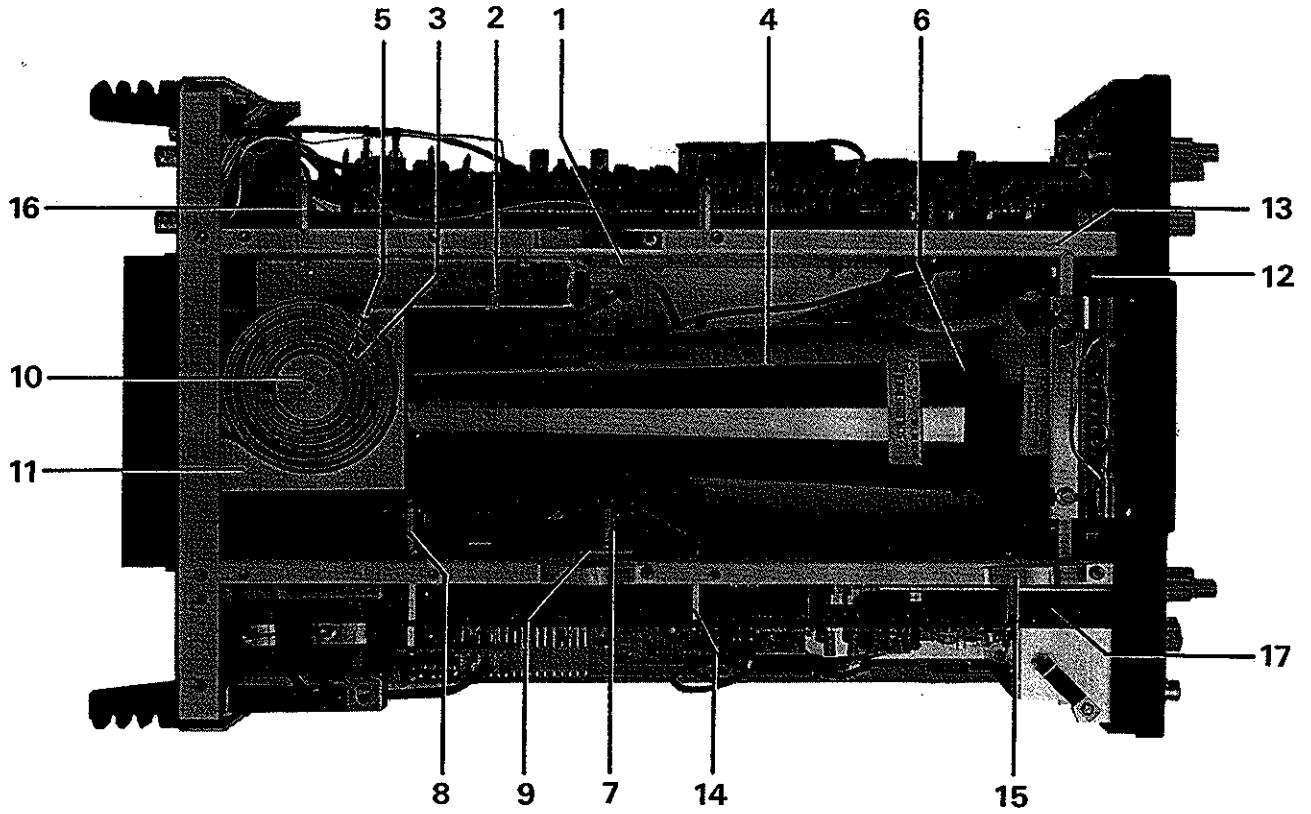

6.6.- BOTTOM VIEW

Number	Désignation	ENERTEC Réf.
1	Transistor heatsink bracket	841 032 057
2	Power supply card shield bracket	841 132 030
3	Insulating plate	867 552 042
4	Transistor insulating washer	879 144 011
5	Ring grommet	253 504 100

